

DVD Player/ Video Cassette Recorder

Operating Instructions

For customers in the USA

If you have any questions about your Sony DVD-VCR, you may call **Sony Customer Information Services Company** at 1-800-VHS-SONY (847-7669).

For all other Sony product questions, please call **Sony Customer Information Services Company** at 1-800-222-SONY (7669).

Or write to: **Sony Customer Information Services Company** 12451 Gateway Boulevard Ft. Myers, FL 33913

For Customers in Canada

If this product is not working properly, please call 1-877-602-2008 for **Peace of Mind Warranty Replacement service**.

For other product related questions please contact our **Customer Information Service Center** at 1-877-899-7669 or write to us at: Customer Information Service 115 Gordon Baker Road, Toronto, Ontario, M2H 3R6



SLV-D300P

WARNING

To prevent fire or shock hazard, do not expose the unit to rain or moisture. To avoid electrical shock, do not open the cabinet. Refer servicing to qualified personnel only. To prevent fire or shock hazard, do not place objects filled with liquids, such as vases, on the apparatus.

CAUTION

The use of optical instruments with this product will increase eye hazard. As the laser beam used in this DVD player is harmful to eyes, do not attempt to disassemble the cabinet.

Refer servicing to qualified personnel only.

USE OF ANY CONTROLS, ADJUSTMENTS, OR PROCEDURES OTHER THAN THOSE SPECIFIED HEREIN MAY RESULT IN HAZARDOUS RADIATION EXPOSURE.

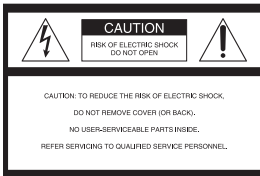

This symbol is intended to alert the user to the presence of uninsulated “dangerous voltage” within the product’s enclosure that may be of sufficient magnitude to constitute a risk of electric shock to persons.



This symbol is intended to alert the user to the presence of important operating and maintenance (servicing) instructions in the literature accompanying the appliance.

CAUTION

TO PREVENT ELECTRIC SHOCK, MATCH WIDE BLADE OF PLUG TO WIDE SLOT, FULLY INSERT.

For customers in the U.S.A

Owner's Record

The model and serial numbers are located at the rear of the unit. Record the serial number in the space provided below. Refer to them whenever you call upon your Sony dealer regarding this product.

Model No. SLV-D300P
Serial No. _____

CAUTION

You are cautioned that any changes or modifications not expressly approved in this manual could void your authority to operate this equipment.

Note

This equipment has been tested and found to comply with the limits for a Class B digital device, pursuant to Part 15 of the FCC Rules. These limits are designed to provide reasonable protection against harmful interference in a residential installation. This equipment generates, uses, and can radiate radio frequency energy and, if not installed and used in accordance with the instructions, may cause harmful interference to radio communications. However, there is no guarantee that interference will not occur in a particular installation. If this equipment does cause harmful interference to radio or television reception, which can be determined by turning the equipment off and on, the user is encouraged to try to correct the interference by one or more of the following measures:

- Reorient or relocate the receiving antenna.
- Increase the separation between the equipment and receiver.
- Connect the equipment into an outlet on a circuit different from that to which the receiver is connected.
- Consult the dealer or an experienced radio/TV technician for help.

Welcome!

Thank you for purchasing this Sony DVD Player/Video Cassette Recorder. Before operating this player, please read this manual thoroughly and retain it for future reference.

General Precautions

- Operate the unit only on 120 V AC, 60 Hz.
- This unit is not disconnected from the AC power source (mains) as long as it is connected to the wall outlet, even if the unit itself has been turned off.
- Unplug the unit from the wall outlet if you do not intend to use it for an extended period of time. To disconnect the cord, pull it out by the plug, never by the cord.
- If the unit is brought directly from a cold to a warm location, moisture may condense inside the unit and cause damage to the video head and tape. When you first install the unit, or when you move it from a cold to a warm location, wait for about three hours before operating the unit.
- Do not install the unit in a confined space such as a book or similar unit.
- Do not install the unit in an inclined position. It is designed to be operated in a horizontal position only.
- Keep the unit and cassettes away from equipment with strong magnets, such as microwave ovens or large loudspeakers.
- Do not place heavy objects on the unit.

Important Safety Instructions

- 1 Read these instructions.
- 2 Keep these instructions.
- 3 Heed all warnings.
- 4 Follow all instructions.
- 5 Do not use this apparatus near water.
- 6 Clean only with dry cloth.
- 7 Do not block any ventilation openings. Install in accordance with the manufacturer's instructions.
- 8 Do not install near any heat sources such as radiators, heat registers, stoves, or other apparatus (including amplifiers) that produce heat.
- 9 Do not defeat the safety purpose of the polarized or grounding-type plug. A polarized plug has two blades with one wider than the other. A grounding type plug has two blades and a third grounding prong. The wide blade or the third prong are provided for your safety. If the provided plug does not fit into your outlet, consult an electrician for replacement of the obsolete outlet.
- 10 Protect the power cord from being walked on or pinched particularly at plugs, convenience receptacles, and the point where they exit from the apparatus.
- 11 Only use attachments/accessories specified by the manufacturer.
- 12 Use only with the cart, stand, tripod, bracket, or table specified by the manufacturer, or sold with the apparatus. When a cart is used, use caution when moving the cart/apparatus combination to avoid injury from tip-over.
- 13 Unplug this apparatus during lightning storms or when unused for long periods of time.
- 14 Refer all servicing to qualified service personnel. Servicing is required when the apparatus has been damaged in any way, such as power-supply cord or plug is damaged, liquid has been spilled or objects have fallen into the apparatus, the apparatus has been exposed to rain or moisture, does not operate normally, or has been dropped.

DVD Precautions

On safety

- Caution – The use of optical instruments with this product will increase eye hazard.
- To prevent fire or shock hazard, do not place objects filled with liquids, such as vases, on the apparatus.
- Should any solid object or liquid fall into the cabinet, unplug the player and have it checked by qualified personnel before operating it any further.

On operation

- If the player is brought directly from a cold to a warm location, or is placed in a very damp room, moisture may condense on the lenses inside the player. Should this occur, the player may not operate properly. In this case, remove the disc and leave the player turned on for about half an hour until the moisture evaporates.
- When you move the player, take out any discs. If you don't, the disc may be damaged.

On adjusting volume when playing DVD

Do not turn up the volume while listening to a section with very low level inputs or no audio signals. If you do, the speakers may be damaged when a peak level section is played.

On cleaning discs

Do not use a commercially available cleaning disc. It may cause a malfunction.

IMPORTANT NOTICE

Caution: This player is capable of holding a still video image or on-screen display image on your television screen indefinitely. If you leave the still video image or on-screen display image displayed on your TV for an extended period of time you risk permanent damage to your television screen. Projection televisions are especially susceptible to this.

Table of contents

- 2 WARNING
 - 2 Welcome!
 - 2 General Precautions
 - 3 Important Safety Instructions
 - 3 DVD Precautions
 - 6 About this manual
 - 6 This player can play the following discs
 - 7 Notes about discs
-

Getting Started

- 8 Step 1 : Unpacking
 - 9 Step 2 : Setting up the remote commander
 - 12 Step 3 : Basic hookups
 - 19 Step 4 : Selecting a language
 - 20 Step 5 : Setting the clock
 - 24 Step 6 : Presetting channels
-

Basic Operations

- 28 Playing discs
- 31 Guide to the on-screen display
- 33 Playing a tape
- 36 Recording TV programs
- 39 Recording TV programs using the timer
- 42 Checking/changing/canceling timer settings

Advanced Hookups

- 44 A/V Receiver hookup
- 46 S-Video/Component Video hookup

DVD Settings and Adjustements

- 48 Audio Setup
- 51 Screen Setup

- 54 Setting the display or sound track language
- 56 Parental Control (limiting playback by children)

DVD Additional Operations

- 59 Using the DVD's menu
- 60 Zooming into a scene
- 61 Changing the angles
- 62 Displaying the subtitle
- 63 Various play mode functions (Program play, Shuffle play, Repeat play)
- 67 Using bookmarks
- 69 Changing the sound
- 70 Virtual surround setting
- 72 Playing an MP3 audio track
- 76 Playing JPEG image files
- 79 Playing VIDEO CDs with "MENU ON/OFF" Functions

VCR Additional Operations

- 81** Quick Timer Recording
- 82** Recording stereo and bilingual programs
- 83** Searching using various functions
- 85** Adjusting the picture (tracking)
- 86** Changing menu options
- 87** Editing with another VCR

Additional Information

- 89** General setup information
- 92** Troubleshooting
- 97** Glossary
- 99** Specifications
- 101** Index to parts and controls
- 106** DVD Audio/Subtitle Language
- 107** Index

Caution

For use of the VCR





Television programs, films, video tapes and other materials may be copyrighted. Unauthorized recording of such material may be contrary to the provisions of the copyright laws. Also, use of this recorder with cable television transmission may require authorization from the cable television transmission and/or program owner.

For use of the DVD player

This product incorporates copyright protection technology that is protected by method claims of certain U.S. patents, other intellectual property rights owned by Macrovision Corporation, and other rights owners. Use of this copyright protection technology must be authorized by Macrovision Corporation, and is intended for home and other limited viewing uses only unless otherwise authorized by Macrovision Corporation. Reverse engineering or disassembly is prohibited.



About this manual

- The meaning of the icons used in this manual is described below:

Icon	Meaning
	Functions available for DVD VIDEOS and DVD-RWs/ DVD-Rs in video mode or DVD+RWs/DVD+Rs
	Functions available for VIDEO CDs, Super VCDs or CD-Rs/ CD-RWs in video CD format or Super VCD format
	Functions available for DATA CDs (CD-ROMs/CD-Rs/CD-RWs containing MP3* audio tracks or JPEG files)
	Functions available for music CDs or CD-Rs/CD-RWs in music CD format
	Functions available for VHS VIDEOS

* MP3 (MPEG 1 Audio Layer 3) is a standard format defined by ISO/MPEG which compresses audio data.

This player can play the following discs

Format of discs	
DVD VIDEO	
VIDEO CD	
Music CD	

The “DVD VIDEO” logo is a trademark.

Region code

Your player has a region code printed on the back of the unit and only will play DVD VIDEO discs (playback only) labeled with identical region codes. This system is used to protect copyrights.

DVDs labeled  will also play on this player.

If you try to play any other DVD, the message “Playback prohibited by area limitations.” will appear on the TV screen. Depending on the DVD, no region code indication may be labeled even though playing the DVD is prohibited by area restrictions.



Example of discs that the player cannot play

The player cannot play the following discs:

- All CD-ROMs (including PHOTO CDs)/CD-Rs/CD-RWs other than those recorded in the following formats:
 - music CD format
 - video CD format
 - MP3 or JPEG format that conforms to ISO9660* Level 1/Level 2, or its extended format, Joliet
- Data part of CD-Extras
- DVD-RWs in VR mode
- DVD-ROMs
- DVD Audio discs
- HD layer on Super Audio CDs

* A logical format of files and folders on CD-ROMs, defined by ISO (International Standard Organization).

Also, the player cannot play the following discs:

- A DVD with a different region code.
- A disc recorded in a color system other than NTSC, such as PAL or SECAM (this player conforms to the NTSC color system).
- A disc that has a non-standard shape (e.g., card, heart).
- A disc with paper or stickers on it.
- A disc that has the adhesive of cellophane tape or a sticker still left on it.

Note

Some DVD-RWs/DVD-Rs, DVD+RWs/DVD+Rs or CD-Rs/CD-RWs cannot be played on this player due to the recording quality or physical condition of the disc, or the characteristics of the recording device. Furthermore, the disc will not play if it has not been correctly finalized. For more information, see the operating instructions for the recording device. Note that discs created in the Packet Write format cannot be played.

Note on playback operations of DVDs and VIDEO CDs

Some playback operations of DVDs and VIDEO CDs may be intentionally set by software producers. Since this player plays DVDs and VIDEO CDs according to the disc contents the software producers designed, some playback features may not be available. Also, refer to the instructions supplied with the DVDs or VIDEO CDs.

Music discs encoded with copyright protection technologies

This product is designed to playback discs that conform to the Compact Disc (CD) standard. Recently, various music discs encoded with copyright protection technologies are marketed by some record companies. Please be aware that among those discs, there are some that do not conform to the CD standard and may not be playable by this product.

Notes about discs

- To keep the disc clean, handle the disc by its edge. Do not touch the surface.



- Do not expose the disc to direct sunlight or heat sources such as hot air ducts, or leave it in a car parked in direct sunlight as the temperature may rise considerably inside the car.
- After playing, store the disc in its case.
- Clean the disc with a cleaning cloth. Wipe the disc from the center out.



Do not use solvents such as benzene, thinner, commercially available cleaners, or anti-static spray intended for vinyl LPs.

Step 1 : Unpacking

Check that you have received the following items with the DVD-VCR:

- Remote commander

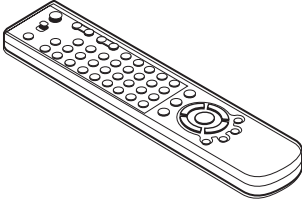

- Size AA (R6) batteries

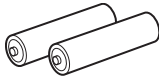

- 75-ohm coaxial cable with F-type connectors

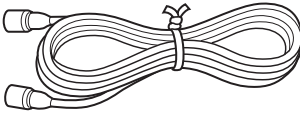

- Audio/video cord
(pinplug ×3 ↔ pinplug ×3)

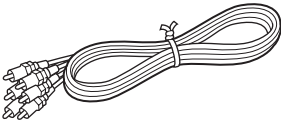

Note

- The supplied remote commander is for the exclusive use of this DVD-VCR.

Step 2 : Setting up the remote commander

Inserting the batteries

Insert two size AA (R6) batteries by matching the + and – on the batteries to the diagram inside the battery compartment.

Insert the negative (–) end first, then push in and down until the positive (+) end clicks into position.

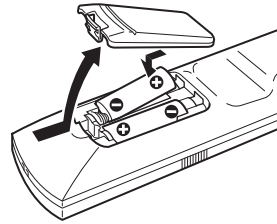

Using the remote commander

You can use this remote commander to operate this DVD-VCR and a Sony TV. Buttons on the remote commander marked with an orange dot (•) can be used to operate your Sony TV.

If the TV does not have the  symbol near the remote sensor, this remote commander will not operate the TV.

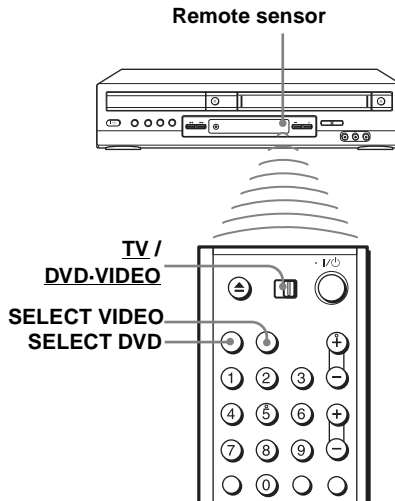

To operate	Set <u>TV / DVD-VIDEO</u> to
the DVD player	<u>DVD-VIDEO</u> , then press <u>SELECT DVD</u> and point at the remote sensor at the DVD-VCR
the VCR	<u>DVD-VIDEO</u> , then press <u>SELECT VIDEO</u> and point at the remote sensor at the DVD-VCR
your TV	<u>TV</u> and point at the remote sensor at your TV

Notes

- With normal use, the batteries should last about three to six months.
- If you do not use the remote commander for an extended period of time, remove the batteries to avoid possible damage from battery leakage.
- Do not use a new battery with an old one.
- Do not use different types of batteries.
- Do not leave the remote commander in an extremely hot or humid place.
- Do not drop any foreign object into the remote casing, particularly when replacing the batteries.
- Do not expose the remote sensor to direct light from the sun or lighting apparatus. Doing so may cause a malfunction.

continued

Controlling other TVs with the remote commander

The remote commander is preprogrammed to control non-Sony TVs. If your TV is listed in the following table, set the appropriate manufacturer's code number.

- 1 Set TV / DVD-VIDEO at the top of the remote commander to TV.
- 2 Hold down I/⏻, and enter your TV's code number using the number buttons. Then release I/⏻.

Now you can use the I/⏻, VOL +/-, CH +/-, MUTING*, TV/VIDEO and ENTER* buttons to control your TV. You can also use the buttons marked with a dot (•) to control a Sony TV. To control the DVD-VCR, reset TV / DVD-VIDEO to DVD-VIDEO.

* for Sony TV only

Code numbers of controllable TVs

If more than one code number is listed, try entering them one at a time until you find the one that works with your TV.

TV brand	Code number
Sony	01
Akai	04
AOC	04
Centurion	12
Coronado	03
Curtis-Mathes	12
Daytron	12
Emerson	03, 04, 14
Fisher	11
General Electric	06, 10
Gold Star	03, 04, 17
Hitachi	02, 03
J.C.Penney	04, 12
JVC	09
KMC	03
Magnavox	03, 08, 12
Marantz	04, 13
MGA/Mitsubishi	04, 12, 13, 17
NEC	04, 12

TV brand	Code number
Panasonic	06, 19
Philco	03, 04
Philips	08
Pioneer	16
Portland	03
Quasar	06, 18
Radio Shack	05, 14
RCA	04, 10
Sampo	12
Sanyo	11
Scott	12
Sears	07, 10, 11
Sharp	03, 05, 18
Sylvania	08, 12
Teknika	03, 08, 14
Toshiba	07
Wards	03, 04, 12
Yorx	12
Zenith	15

Notes

- If you enter a new code number, the code number previously entered will be erased.
- If the TV uses a different remote control system from the one programmed to work with the DVD-VCR, you cannot control your TV with the remote commander.
- When you replace the batteries of the remote commander, the code number may change. Set the appropriate code number every time you replace the batteries.

Step 3 : Basic hookups

Before you get started

- Be sure to disconnect the AC power cord of each component before connecting.
- Turn off the power to all equipment.
- Do not connect the AC power cords until all of the connections are completed. If you connect the AC power cord before the connections are completed, you may not be able to use the Plug and Play function.
- Be sure you make connections firmly. Loose connections may cause picture distortion.
- If your TV does not match any of the examples provided, see your nearest Sony dealer or qualified technician.

Selecting the best hookup option

There are many ways in which your DVD-VCR can be hooked up. To hook up your DVD-VCR so that it works best for you, first scan through the table below. Then use the accompanying diagrams and procedures on the following pages to set up your DVD-VCR.

If your TV has audio/video inputs, refer to page 13 for audio/video (A/V) hookup. Then follow one of the hookups below. If your TV does not have A/V inputs, go directly to one of the hookups below.

If you have	Use	Refer to
Antenna only, no cable TV	Hookup 1 (Plug and Play)	Pages 14 and 15
No cable box or cable box with only a few scrambled channels	Hookup 2 (Plug and Play)	Pages 16 and 17
Cable box with many scrambled channels	Hookup 3	Page 18

After you have completed the connections, follow the instructions for setup.

After you have completed the setup, you are ready to use your DVD-VCR. Procedures differ depending on the hookup you used.

Caution

Connections between the DVD-VCR's VHF/UHF connector and the antenna terminals of the TV receiver should be made only as shown in the following instructions. Failure to do so may result in operation that violates the regulations of the Federal Communications Commission regarding the use and operation of RF devices. Never connect the output of the DVD-VCR to an antenna or make simultaneous (parallel) antenna and DVD-VCR connections at the antenna terminals of your receiver.

Note to CATV system installer (in USA)

This reminder is provided to call the CATV system installer's attention to Article 820-40 of the NEC that provides guidelines for proper grounding and, in particular, specifies that the cable ground shall be connected to the grounding system of the building, as close to the point of cable entry as practical.

Audio/video (A/V) hookup

If your TV has audio/video (A/V) input jacks, you will get better picture and sound if you hook up your DVD-VCR using these connections. If your TV does not have A/V inputs, see the following pages for antenna or cable hookups. Note that “Advanced Hookups” (page 44) explains additional hookup methods that will optimize the picture and sound for a true “hometheater” experience.

If you are not planning to use your DVD-VCR to record programs, you only need to make the connections shown on this page. If you want to record regular or cable TV programs, complete these connections first, and then go to the following pages for antenna or cable hookups.

A Use this hookup if your TV has stereo jacks

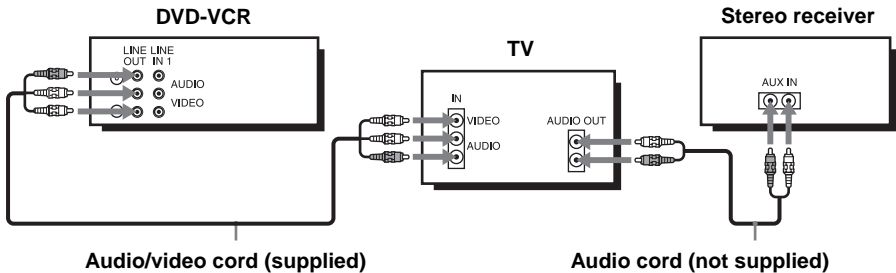

B Use this hookup if your TV does not have stereo jacks

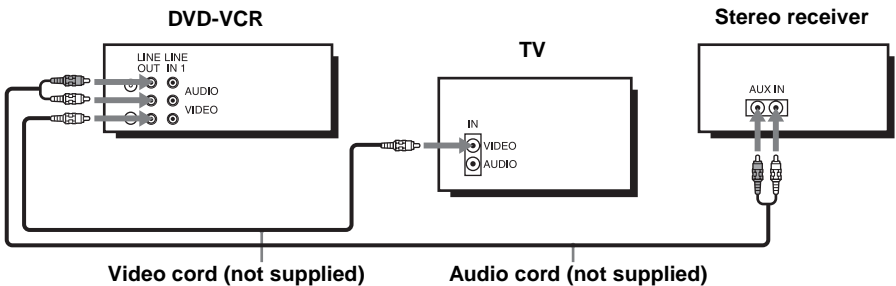

Notes

- To play a tape/disc in stereo, you must use the A/V connection.
- If you do not have a stereo receiver, connect the white LINE OUT/AUDIO L jack to the AUDIO IN jack on your TV.

continued

Hookup 1 (Plug and Play)

Antenna hookup

Make the following connections if you are using an antenna (if you do not have cable TV).

A Use this hookup if you are using:

- VHF/UHF antenna (you get channels 2–13 and channels 14 and higher)
- UHF-only antenna (you get channels 14 and higher)
- Separate VHF and UHF antennas

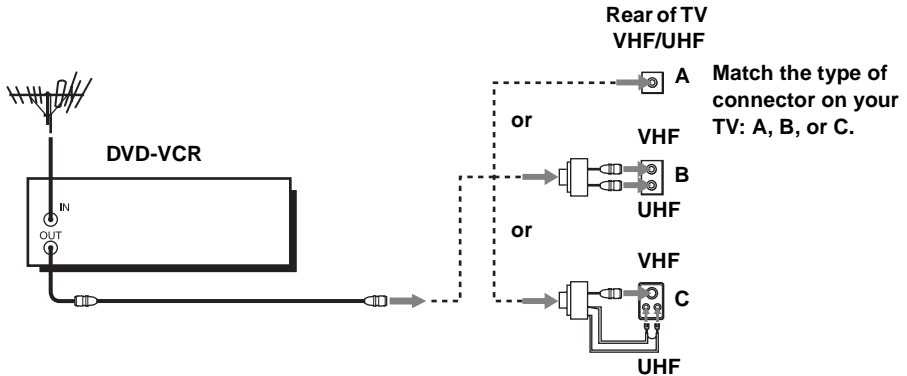

B Use this hookup if you are using a VHF-only antenna (you get channels 2–13 only)

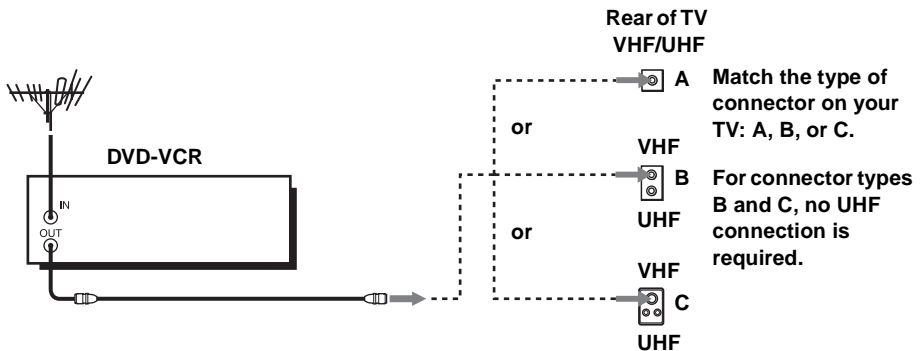

If you cannot connect your antenna cable to the DVD-VCR directly

If your antenna cable is a flat cable (300-ohm twin lead cable), attach an external antenna connector (not supplied) so you can connect the cable to the RF IN connector. If you have separate cables for VHF and UHF antennas, you should use a U/V band mixer (not supplied) (page 91).

Hookup 1 : DVD-VCR setup

Plug the DVD-VCR into an AC outlet.

The DVD-VCR automatically presets the DVD-VCR's clock and TV channels when the DVD-VCR is plugged into the AC outlet.

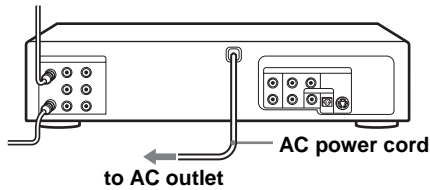

The DVD-VCR starts presetting the clock and channels.

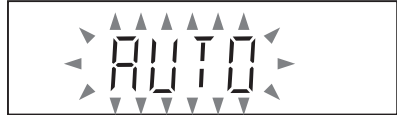

When Auto preset is completed, the current time appears in the display window.



You have now completed DVD-VCR setup.

To change the on-screen display language to French or Spanish, see "Step 4 : Selecting a language" on page 19.

The clock is set using a time signal provided by some TV channels. If the clock is incorrect, or "--:--" appears in the display window, see "Using Manual Clock Set" on page 22.

To add or disable channels manually, see "Presetting/disabling channels manually" on page 26.

Notes

- If you connect the AC power cord before the antenna connections are completed, the channels may be incorrectly set. If this happens, see "Step 6 : Presetting channels" on page 24.
- Do not press any buttons on the DVD-VCR or remote commander during Auto preset.
- Auto preset starts automatically only when you plug in the AC power cord for the first time after you purchase the DVD-VCR.
- Auto preset can be performed by pressing ■ STOP on the unit continuously for 5 seconds or more with the DVD-VCR power turned off.

continued

Hookup 2 (Plug and Play)

You have no cable box, or a cable box with only a few scrambled channels

Recommended use

Use this hookup if you do not have a cable box. Also use this hookup if your cable system scrambles only a few channels.

What you can do with this hookup

- Record any unscrambled channel by selecting the channel on the VCR

What you cannot do

- Record scrambled channels that require a cable box

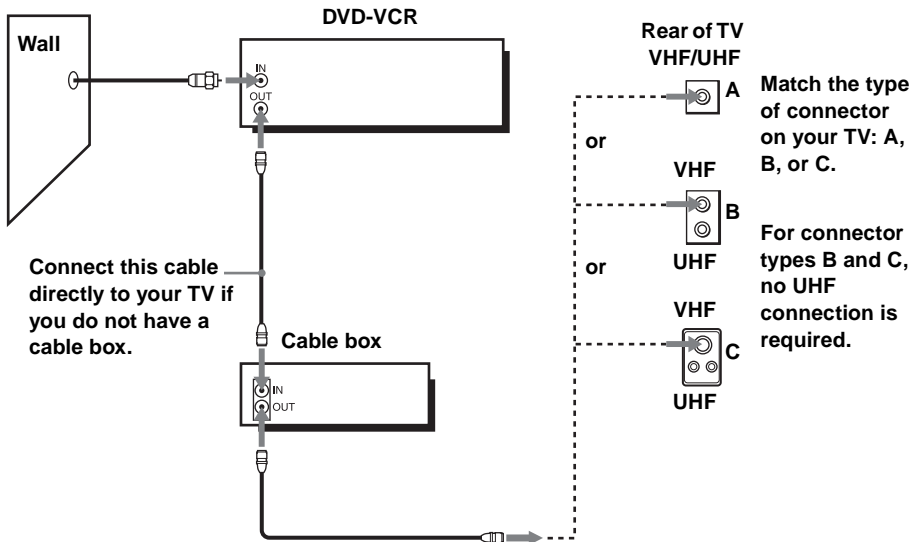

Hookup 2 : DVD-VCR setup

Plug the DVD-VCR into an AC outlet.

The DVD-VCR automatically presets the DVD-VCR's clock and TV channels when the DVD-VCR is plugged into the AC outlet.

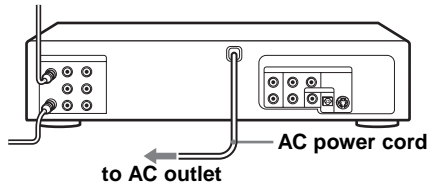

The DVD-VCR starts presetting the clock and channels.

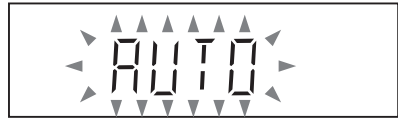

When Auto preset is completed, the current time appears in the display window.



You have now completed DVD-VCR setup.

To change the on-screen display language to French or Spanish, see "Step 4 : Selecting a language" on page 19.

The clock is set using a time signal provided by some TV channels. If the clock is incorrect, or "--:--" appears in the display window, see "Using Manual Clock Set" on page 22.

To add or disable channels manually, see "Presetting/disabling channels manually" on page 26.

Notes

- If you connect the AC power cord before the antenna connections are completed, the channels may be incorrectly set. If this happens, see "Step 6 : Presetting channels" on page 24.
- Do not press any buttons on the DVD-VCR or remote commander during Auto preset.
- Auto preset starts automatically only when you plug in the AC power cord for the first time after you purchase the DVD-VCR.
- Auto preset can be performed by pressing ■ STOP on the unit continuously for 5 seconds or more with the DVD-VCR power turned off.

continued

Hookup 3

Connecting a cable box with many scrambled channels

Recommended use

Use this hookup if your cable system scrambles all or most channels.

What you can do with this hookup

- Record any channel by selecting the channel on the cable box

What you cannot do

- Record with the cable box turned off
- Record one channel while watching another channel

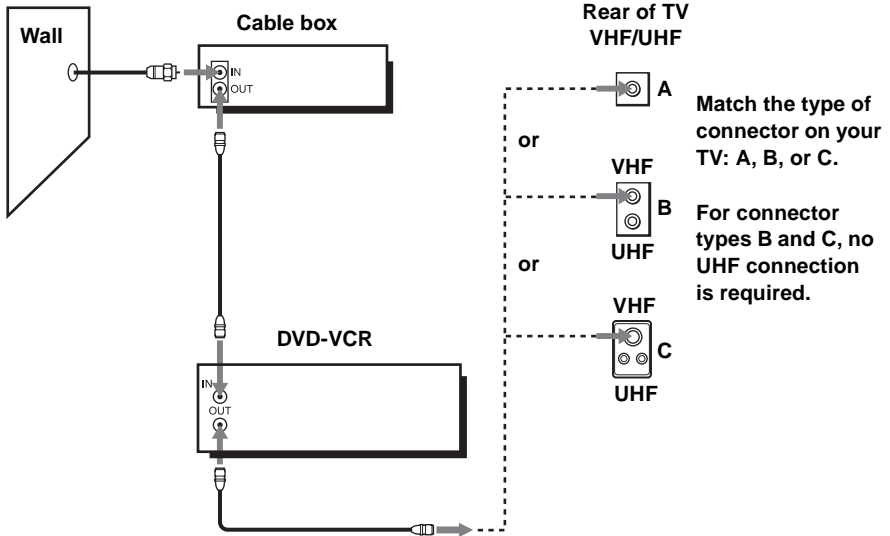

After you have completed hookup...

After you have completed hookup, plug the DVD-VCR into an AC outlet and see “Step 4 : Selecting a language” on page 19.

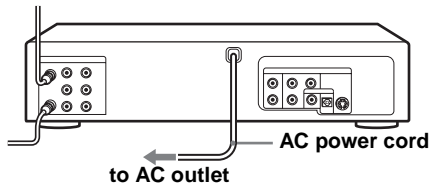



Step 4 : Selecting a language

You can change the on-screen display language.

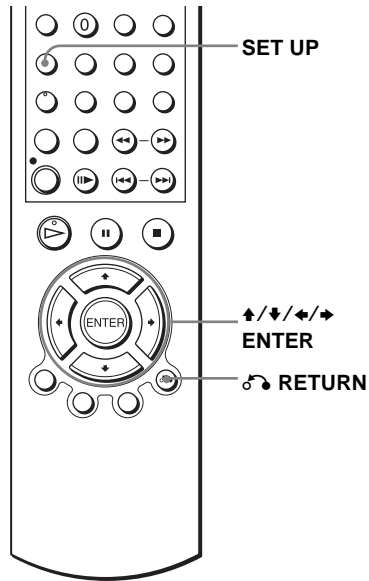

Before you start...

- Turn on the DVD-VCR and your TV.
- To control the DVD-VCR, set **TV / DVD-VIDEO** to **DVD-VIDEO** on the remote (page 9).
- Set the “RF Output Channel” to “3CH” or “4CH” in “OPTION SETUP” menu (page 89). If your TV is connected to the DVD-VCR using A/V connections, set the TV to video input.
- If the DVD player is in play mode, you cannot display the “SETUP MENU.” Stop the DVD playback.



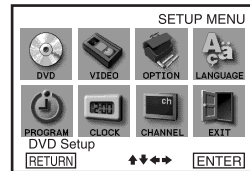

- 1**  Press **SET UP**.
The “**SETUP MENU**” appears.

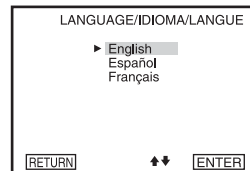

- 2**  Press **↑/↓/←/→** to select  (Language/Idioma/Langue), then press **ENTER**.
The “**LANGUAGE/IDIOMA/LANGUE**” menu appears.



- 3**  Press **↑/↓** to select the desired language, English, Spanish or French, then press **ENTER**.

- 4**  Press **RETURN** to exit the menu.
- RETURN

Step 5 : Setting the clock

Using the Auto Clock Set feature

Some TV and cable channels transmit time signals with their broadcasts. Your DVD-VCR can pick up this time signal to automatically set the clock.

The Auto Clock Set feature works only if a channel in your area is broadcasting a time signal. If broadcasters in your area are not yet sending time signals, set the time manually (page 22).

Before you start...

- Turn on the DVD-VCR and your TV. When using a cable box, turn it on.
- To control the DVD-VCR, set **TV / DVD-VIDEO** to **DVD-VIDEO** on the remote (page 9).
- Set the “RF Output Channel” to “3CH” or “4CH” in “OPTION SETUP” menu (page 89). If your TV is connected to the DVD-VCR using A/V connections, set the TV to video input.
- If the DVD player is in play mode, you cannot display the “SETUP MENU.” Stop the DVD playback.

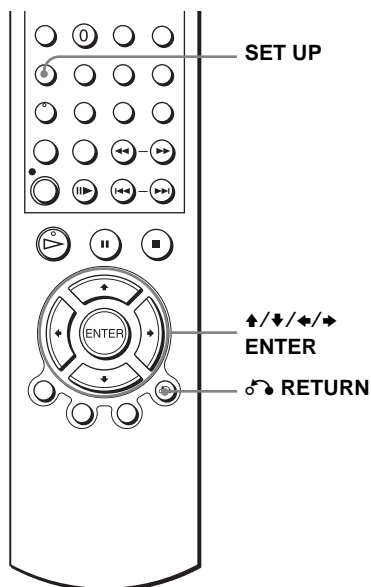

1



Press SET UP.
The “SETUP MENU” appears.

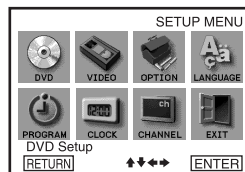

2



Press  to select (Clock Set/Adjust), then press ENTER.
The “CLOCK SET/ADJUST” menu appears.

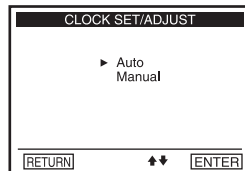

3



Press \uparrow/\downarrow to select “Auto”, then press ENTER.

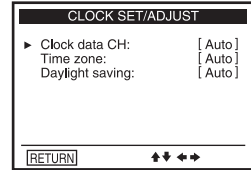

4



Press \uparrow/\downarrow to select the item you want. Then press \leftarrow/\rightarrow to make the setting.

- For “Clock data CH”
Leave the setting to “Auto” to have the DVD-VCR automatically search for a channel that carries a time signal. Press \leftarrow/\rightarrow to select a channel that carries a time signal. Use this option if you know of a channel that carries a time signal. Most PBS member stations broadcast a time signal. For the fastest response, select your local PBS station.
- For “Time zone”
Select the time zone of your area, or select “Auto” to have the DVD-VCR automatically set your time zone.
The options are:
Auto \leftrightarrow Atl. (Atlantic) \leftrightarrow East (Eastern)
 \leftrightarrow Cen. (Central) \leftrightarrow Mtn. (Mountain) \leftrightarrow
Pac. (Pacific) \leftrightarrow Alas (Alaska) \leftrightarrow
Haw. (Hawaii) \leftrightarrow Auto
- For “Daylight saving”
Select “Yes” or “No” (standard time), or “Auto” to have the DVD-VCR automatically set the daylight saving time.

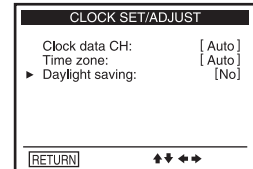
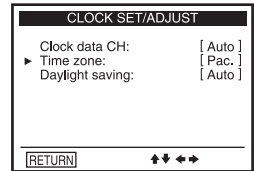
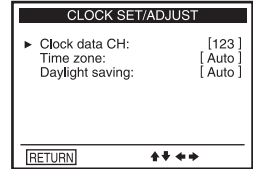

5



RETURN

Press \circlearrowleft RETURN repeatedly to exit the menu.

6

To activate the Auto Clock Set function, turn off the DVD-VCR.

continued

Notes

- The clock cannot be set automatically if you do not receive a channel that carries a time signal in your area. If so, set the clock manually (page 22).
- If there are only a few channels in your area that carry time signals, setting the clock automatically may take up to about 20 minutes. If nothing happens even after you wait about 20 minutes, set the clock manually (page 22).
- If you made Hookup 3, make sure you leave the cable box on.
- To record TV programs using the timer, you must set the clock accurately.
- The clock display appears when VIDEO mode is selected with no tape inserted or when the DVD-VCR is turned off.

Using Manual Clock Set

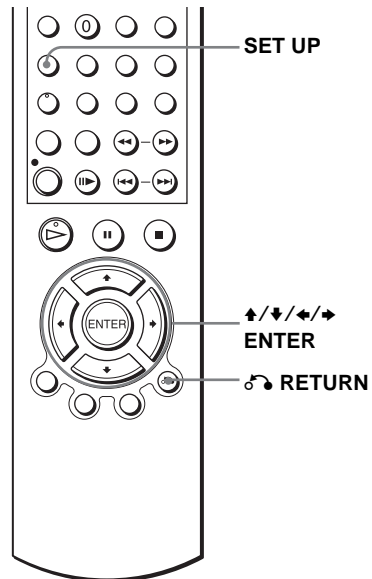

Before you start...

- Turn on the DVD-VCR and your TV.
- To control the DVD-VCR, set TV / DVD-VIDEO to DVD-VIDEO on the remote (page 9).
- Set the “RF Output Channel” to “3CH” or “4CH” in “OPTION SETUP” menu (page 89). If your TV is connected to the DVD-VCR using A/V connections, set the TV to video input.
- If the DVD player is in play mode, you cannot display the “SETUP MENU.” Stop the DVD playback.

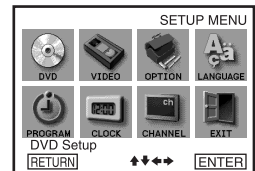

- 1**  Press SET UP.
The “SETUP MENU” appears.



- 2**  Press  (Clock Set/Adjust), then press ENTER.
The “CLOCK SET/ADJUST” menu appears.

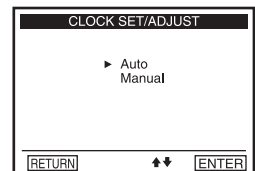

3



Press \uparrow/\downarrow to select "Manual," then press ENTER.

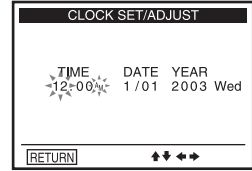

4



Press \uparrow/\downarrow to set the hour.

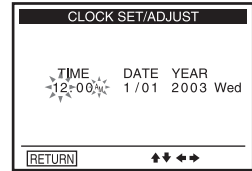

5



Press \rightarrow to select the minutes and press \uparrow/\downarrow to set the minutes.

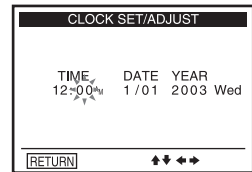

6

Set the month, day, and year in the same way as the minutes.
The day of the week is set automatically.

7



RETURN

Press \rightarrow RETURN to save the clock setting.

Notes

- To record TV programs using the timer, you must set the clock accurately.
- The clock display appears when VIDEO mode is selected with no tape inserted or when the DVD-VCR is turned off.

Step 6 : Presetting channels

This DVD-VCR is capable of receiving VHF channels 2 to 13, UHF channels 14 to 69 and unscrambled CATV channels 1 to 125. First, we recommend that you preset the receivable channels in your area using automatic presetting methods. Then, if there are any unwanted channels, disable them manually. If you have already decided which channels you wish to preset, set them directly using manual presetting methods (page 26).

Presetting all receivable channels automatically

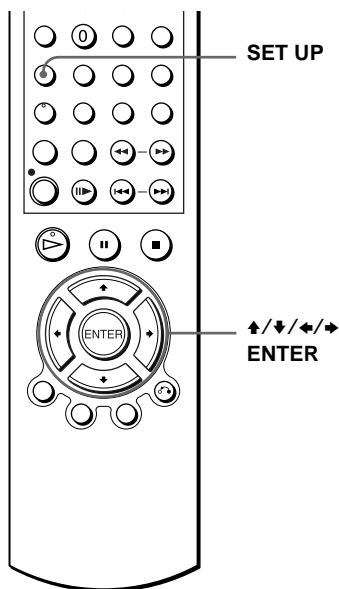

Before you start...

- Turn on the DVD-VCR and your TV. When using a cable box, turn it on.
- To control the DVD-VCR, set TV / DVD-VIDEO to DVD-VIDEO on the remote (page 9).
- Set the "RF Output Channel" to "3CH" or "4CH" in "OPTION SETUP" menu (page 89). If your TV is connected to the DVD-VCR using A/V connections, set the TV to video input.
- If the DVD player is in play mode, you cannot display the "SETUP MENU." Stop the DVD playback.

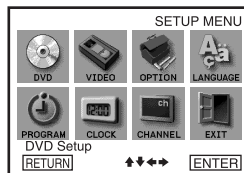

- 1**  Press SET UP.
The "SETUP MENU" appears.



- 2**  Press  (Channel Setup), then press ENTER.
The "CHANNEL SETUP" menu appears.

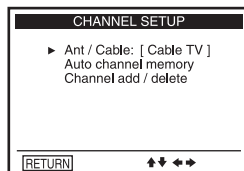

3



Press \uparrow/\downarrow to select "Ant/Cable."

4



- To preset cable TV channels:
Press \leftarrow/\rightarrow to select "Cable TV."

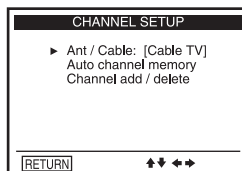

- To preset VHF and UHF channels:
Press \leftarrow/\rightarrow to select "Antenna."

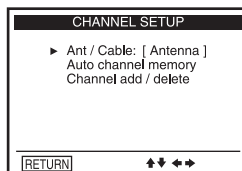

5



Press \uparrow/\downarrow to select "Auto channel memory," then press ENTER.

All receivable channels are preset in numerical sequence. When no more receivable channels can be found, presetting stops and the picture from the lowest numbered channel is displayed on the TV screen.

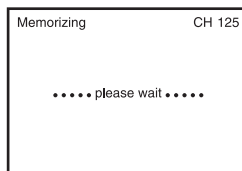



continued

Presetting/disabling channels manually

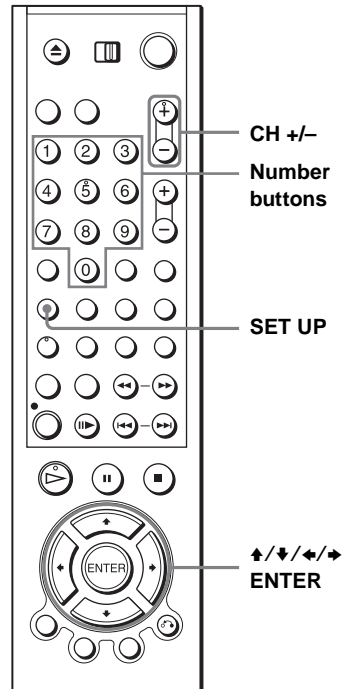

Before you start...

- Turn on the DVD-VCR and your TV.
When using a cable box, turn it on.
- To control the DVD-VCR, set **TV / DVD-VIDEO** to **DVD-VIDEO** on the remote (page 9).
- Set the “RF Output Channel” to “3CH” or “4CH” in “OPTION SETUP” menu (page 89). If your TV is connected to the DVD-VCR using A/V connections, set the TV to video input.
- If the DVD player is in play mode, you cannot display the “SETUP MENU.” Stop the DVD playback.

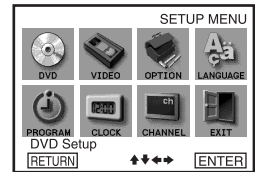

1  Press **SET UP**.
The “SETUP MENU” appears.



2  Press **↑/↓/←/→** to select  (Channel Setup) then press **ENTER**.
The “CHANNEL SETUP” menu appears.

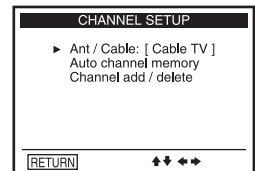

3  Press **↑/↓** to select “Channel add/delete,” then press **ENTER**.

4

• CH/
TRACKING

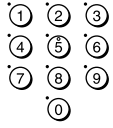

To preset/disable a channel:

- 1 Press CH +/- or number buttons to enter the channel number.
- 2 Press ←/→ to select ADD (in memory) or DELETE (deleted).
- 3 Press ENTER.

Channel to be preset

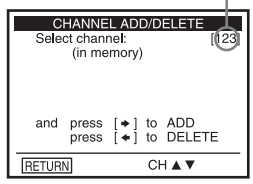

Channel to be disabled

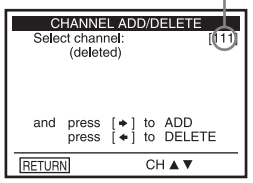

5



RETURN

Press RETURN repeatedly to exit the menu.

Playing discs **DVD** **VCD** **CD** **DATA-CD**

Depending on the disc, some operations may be different or restricted. Refer to the operating instructions supplied with your disc.

Before you start ...

- Turn on the DVD-VCR and your TV.
- Switch the input selector on your TV so that the signal from the player appears on the TV screen.
- Set **TV / DVD-VIDEO** to **DVD-VIDEO**, then press **SELECT DVD** to control the DVD player (page 9).

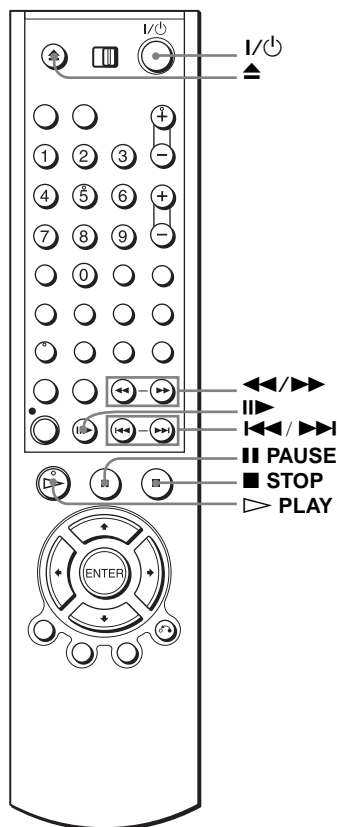

1



Press  to open the disc tray and place a disc on the disc tray.



with the playback side facing down

2



Press  PLAY.

The disc tray closes and the DVD player starts playback. The display window shows the playback time*.

Depending on the disc, a menu may appear on the TV screen.

For DVDs, see page 59. For VIDEO CDs, see page 79.

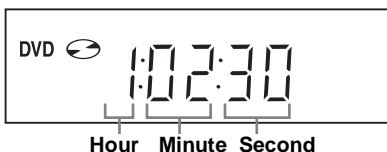

* “-----” appears when no disc is loaded.

Additional tasks

To	Press
Stop play	■ STOP
Pause play*	⏸ PAUSE
Resume play after pause	 PLAY
Advance by frame in pause mode	⏪▶
Go to the next chapter, track, or scene in continuous play mode	⏭ on the remote
Go back to the previous chapter, track, or scene in continuous play mode	⏮ on the remote
Stop play and remove the disc	⏏

* If you pause the DVD player for more than 5 minutes, the DVD player will automatically stop.

To Resume playback for the current disc (Resume Play)

The DVD player remembers the point where you stopped the disc even if the DVD player enters standby mode by pressing I/⏏.

1 While playing a disc, press ■ STOP to stop playback.

2 Press  PLAY.

The DVD player starts playback from the point where you stopped the disc in Step 1.

To locate a point quickly by playing a disc in fast forward or fast reverse in continuous play mode (DVD, VIDEO CD and CD only)

Press ⏮ or ⏭.

For DVD or Video CD, each time you press the button, the playback speed changes as follows.

×2 → FF1/FR1 → FF2/FR2 → FF3/FR3 → FF4/FR4 → FF5/FR5 (DVD only)

Release the button at the desired speed.

For CD, the searching speed does not change (FF2/FR2 play).

When you find the point you want, press  PLAY.

To watch slow motion in continuous play mode (DVD and VIDEO CD only)

Press **⏸** PAUSE, then press **⏮** SLOW **⏭**. With each press, the playback speed changes cyclically as follows.

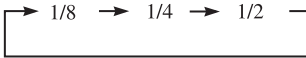

To resume normal playback, press **▶** PLAY.

Notes

- You can change the screen type using the “SCREEN SETUP” menu. (See “Screen Setup” on page 51)
- Do not perform VIDEO playback while playing back a disc.
- If you play a DVD or VIDEO CD that has scratches, the player may stop playback at the point of the scratch.
- You cannot change the MP3 or the Multi Session CD playback speed.
- VIDEO CD fast forward/reverse and slow motion play cannot be paused.
- During CD fast forward/reverse play, no sound is output.
- The PROGRESSIVE button is not available when the DVD player is in play mode. Use the PROGRESSIVE button in stop mode.

Notes on playing DTS* sound tracks on a CD

- When playing DTS-encoded CDs, excessive noise will be heard from the analog stereo jacks. To avoid possible damage to the audio system, the consumer should take proper precautions when the analog stereo jacks of the DVD player are connected to an amplification system. To enjoy DTS Digital Surround™ playback, an external 5.1-channel decoder system must be connected to the digital jack of the DVD player.
- Set the sound to “STEREO” using the AUDIO button when you play DTS sound tracks on a CD (page 69).
- Do not play DTS sound tracks without first connecting the DVD player to an audio component having a built-in DTS decoder. The DVD player outputs the DTS signal via the DIGITAL AUDIO OUT (COAXIAL or OPTICAL) jack even if “DTS” is set to “Off” in “AUDIO SETUP” menu (page 49), and may affect your ears or cause your speakers to be damaged.

Notes on playing DVDs with a DTS sound track

- DTS audio signals are output only through the DIGITAL AUDIO OUT (COAXIAL or OPTICAL) jack.
- When you play a DVD with DTS sound tracks, set “DTS” to “On” in “AUDIO SETUP” menu (page 49).
- If you connect the player to audio equipment without a DTS decoder, do not set “DTS” to “On” in “AUDIO SETUP” menu (page 49). A loud noise may come out from the speakers, affecting your ears or causing the speakers to be damaged.

* “DTS” and “DTS Digital Out” are trademarks of Digital Theater Systems, Inc.

Guide to the on-screen display

DVD VCD CD DATA-CD

You can check disc information during playback.

The displayed contents differ according to the type of disc being played.

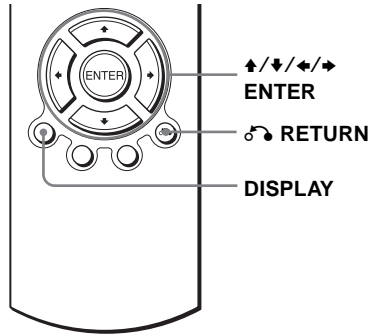

Press DISPLAY. The following information appears; type of disc, current title/track, chapter, counter position, voice language, subtitle language and surround setting. Refer to “DVD Audio/Subtitle Language” on page 106 for the abbreviation of the language.

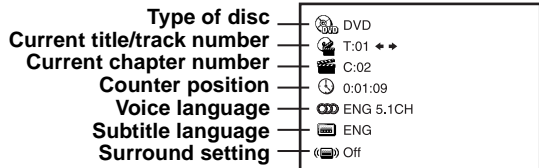

You can playback the desired title/track, chapter or counter position using this menu.

To playback the desired title/track or chapter

- 1 Press **↑/↓** to select the desired item.
- 2 Press **←/→** to change the item.
- 3 Press **ENTER** to start playback.
- 4 Press **DISPLAY** or **RETURN** to turn off the menu.

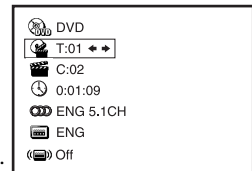

The title/track or chapter icon will appear on the DVD playback screen followed by the current title/track or chapter number and the counter position.

continued

To playback from the desired title/track counter position

- 1 Press **▲/▼** to select the counter position icon.
- 2 Enter the desired elapsed playing time of the current title/track using the number buttons.
- 3 Press **ENTER** to start playback.
- 4 Press **DISPLAY** or **RETURN** to turn off the menu.

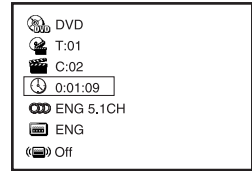

Tip

- You can change the counter position information (playing time or remaining time) using **←/→** (DVD and CD only).

DVD

Indication	Counter information
T * : ** : **	Elapsed playing time of the current title
T- * : ** : **	Remaining time of the current title
C * : ** : **	Elapsed playing time of the current chapter
C- * : ** : **	Remaining time of the current chapter

CD

Indication	Counter information
T * : ** : **	Elapsed playing time of the current track
T- * : ** : **	Remaining time of the current track
D * : ** : **	Elapsed playing time of the disc
D- * : ** : **	Remaining time of the disc

Notes

- The display may not change as operated depending on the disc.
- The display window continue indicating the playing time even when the counter position information on the on-screen display is being changed.

Playing a tape **VHS**

Before you start ...

- Turn on the DVD-VCR and your TV.
- Switch the input selector on your TV so that the signal from the player appears on the TV screen.
- Set **TV / DVD-VIDEO** to **DVD-VIDEO**, then press **SELECT VIDEO** to control the VCR (page 9).

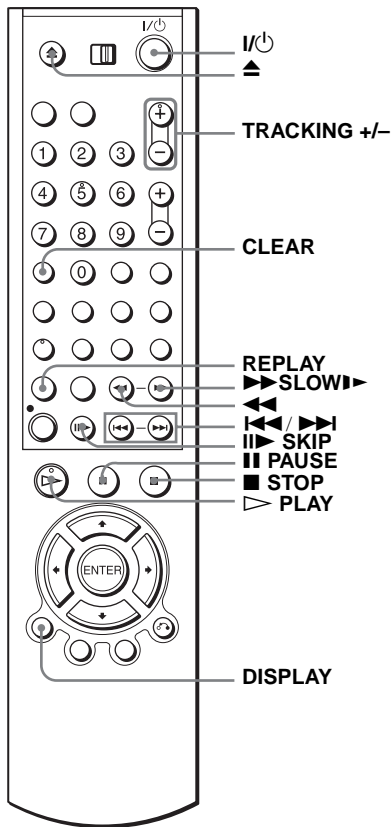

1

Insert a tape.

The VCR starts playing automatically if you insert a tape with its safety tab removed.

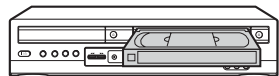

continued

2

PLAY



Press  PLAY.

The display window shows the playback time.

When the tape reaches the end, it will rewind automatically.

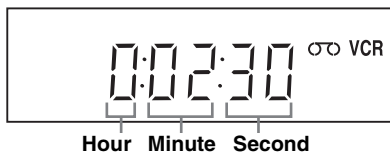

Additional tasks

To	Press
Stop play	■ STOP
Pause play*	PAUSE
Resume play after pause	PAUSE or ▷ PLAY
Fast-forward the tape	▶▶ during stop
Rewind the tape	◀◀ during stop
Eject the tape	▲

* If you pause the VCR for more than 5 minutes, the VCR will automatically resume play.

To play a recently watched scene

You can immediately rewind and playback the scene you want to watch again.

During playback, press REPLAY. The VCR rewinds the tape about 10 seconds in the SP mode (about 15 seconds in the EP mode) on the counter for each press of the button, and restarts playback.

To skip playback

You can skip a scene that you do not want to watch (such as a commercial) and restart playback.

During playback, press **II▶ SKIP**. The VCR skips the tape 30 seconds on the counter each time the button is pressed (up to four times) and playback is resumed.

To turn off the power while rewinding (Rewind Shut Off)

Press **I/⏻** while the tape is rewinding. The power will turn off but the tape will keep rewinding until it reaches the end.

To play/search at various speeds

Playback options	Operation
View the picture during fast-forward or rewind	During fast-forward, hold down ▶▶. During rewind, hold down ◀◀.
Play at high speed	<ul style="list-style-type: none"> • During playback, briefly press ▶▶ or ◀◀. The tape continues to play at 5 times normal speed. • During playback, hold down ▶▶ or ◀◀. The tape continues to play at 5 times normal speed. When you release the button, normal playback resumes.

Playback options	Operation
Play in slow motion	During pause, press ►►SLOW ►►.
Play frame by frame	During pause, press ■►► SKIP.
Play at various speeds (Shuttle play)	During playback, press ◀◀◀ or ►►► SHUTTLE. You can change the playback speed as follows. -×7 ◀◀◀ -×5 ◀◀◀ -×3 ◀◀◀ STILL ◀◀◀ SLOW ◀◀◀ PLAY ▶▶▶ ×2 ▶▶▶ ×3 ▶▶▶ ×5 ▶▶▶ ×7

To resume normal playback

Press ▷ PLAY.

To use the time counter

Press CLEAR at the point on the tape that you want to find later. The counter in the display window resets to “0:00:00.” To search for the counter 0:00:00 point automatically, see “To search for the counter 0:00:00 point” on page 84.



To display the counter on the TV screen, press DISPLAY during normal playback.

Tip

- Adjust the picture using the TRACKING +/- buttons if:
 - Streaks appear while playing in slow motion.
 - The picture shakes during pause.

Notes

- Tapes recorded in the LP mode on other VCRs can be played back on this VCR but the picture quality cannot be guaranteed.
- The counter resets to “0:00:00” whenever a tape is reinserted.
- The counter stops counting when it comes to a portion with no recording.
- When 10 hours have passed, the counter in the display window returns to “0:00:00” and the count starts over again.
- The sound is muted during playback at various speeds.
- The picture may show noise when playing at high speed in reverse.
- While playing a tape, you can display the “SETUP MENU” but the remote commander’s function switches to DVD automatically. Press ⏪ RETURN repeatedly to exit the menu.
- When playback does not start even if you insert a tape with its safety tab removed, set “Auto Play” to “On” in the “VIDEO FUNCTION SETUP” menu (page 86).
- Stop disc playback while playing back a video.
- The VCR can also play S-VHS tapes. The VCR will automatically identify the type of tape inserted in the VCR (either VHS or S-VHS). When S-VHS tapes are played in the VCR, the enhanced resolution will not be visible on screen; there may also be picture distortion while playing the S-VHS tape in slow motion or while utilizing other special playback modes. The VCR will not record in S-VHS mode on an S-VHS tape.

Recording TV programs **VHS**

Before you start ...

- Turn on the DVD-VCR and your TV.
- Switch the input selector on your TV so that the signal from the player appears on the TV screen.
- Set **TV / DVD-VIDEO** to **DVD-VIDEO**, then press **SELECT VIDEO** to control the VCR (page 9).
- To record from a cable box, turn it on.
- Make sure the tape is longer than the total recording time.

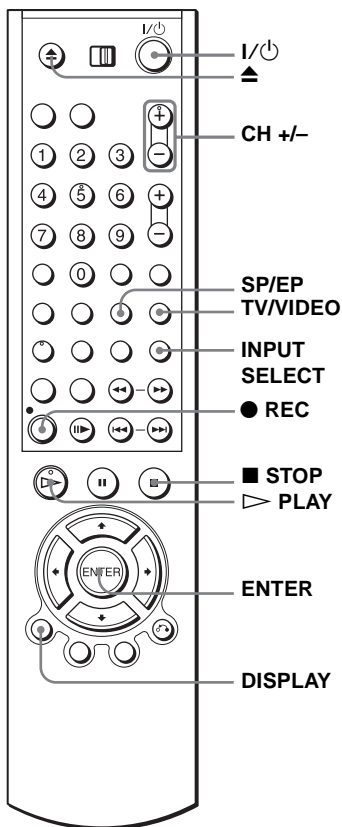

1

Insert a tape with its safety tab in place.

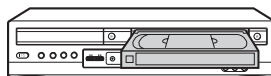

2

• CH/
TRACKING



Press CH +/- to select the channel or line input video source you want to record.



3

SP / EP



Press SP/EP to select the tape speed, SP or EP.

EP (Extended Play) provides recording time three times as long as SP (Standard Play). However, SP produces better picture and audio quality.



4

● REC



Press ● REC to start recording.

“REC” appears in the display window.



To stop recording

Press ■ STOP.

To check the remaining tape length

Press DISPLAY to display the time counter. With the display on, press DISPLAY again to check the remaining time. The white bar indicates the current location in relation to the entire tape length. The remaining time also appears. Press DISPLAY to turn off the indicators.

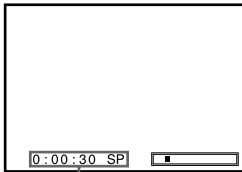

Time counter

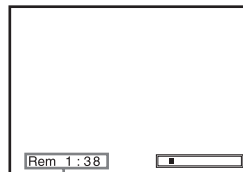

Remaining tape length

To check the remaining tape length of a tape, set “Tape Length” in the “VIDEO FUNCTION SETUP” menu correctly (page 86).

Maximum Recording Time

Tape Length	SP	EP
T-120	2 hrs	6 hrs
T-160	2 hrs 40 mins	8 hrs
T-180	3 hrs	9 hrs

continued

To watch another TV program while recording

- 1 Press TV/VIDEO to display “TV” in the display window.



- 2 If your TV is connected to the VCR using A/V connections, set the TV to the TV's antenna input; if not, skip this step.
- 3 Select another channel on the TV.

To watch a DVD while recording

- 1 Press SELECT DVD to control the DVD player.
- 2 Press ▲ and place the disc on the disc tray.
- 3 Press ▷ PLAY.

The disc tray closes and the DVD player starts playback. The TV screen will automatically change to the DVD playback screen.

To save a recording

To prevent accidental erasure, break off the safety tab as illustrated. To record on the tape again, cover the tab hole with adhesive tape.

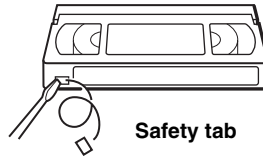

Tips

- To select a channel, you can use the number buttons on the remote commander. Enter the channel number, then press ENTER.
- You can select a video source from the LINE IN 1 or LINE-2 IN jacks using the INPUT SELECT button.
- The display appears on the TV screen indicating information about the tape, but the information will not be recorded on the tape.
- If you do not want to watch TV while recording, you can turn off the TV. When using a cable box, make sure to leave it on.

Notes

- The remaining tape length may not be indicated accurately for short tapes such as T-20 or T-30, or tapes recorded in the LP mode.
- It may take up to one minute for the VCR to calculate and display the remaining tape length after you press DISPLAY.
- You cannot record a DVD to a VCR tape.
- To watch a TV program during video recording, stop disc playback.

Recording TV programs using the timer

VHS

You can preset up to eight programs at a time.

Before you start...

- Check that the DVD-VCR clock is set to the correct time.
- Turn on the DVD-VCR and your TV.
- Switch the input selector on your TV so that the signal from the player appears on the TV screen.
- Set **TV / DVD-VIDEO** to **DVD-VIDEO**, then press **SELECT VIDEO** to control the VCR (page 9).
- When using a cable box, turn it on.
- Insert a tape with its safety tab in place. Make sure the tape is longer than the total recording time.
- If the DVD player is in play mode, you cannot display the “**SETUP MENU**.” Stop the DVD playback.

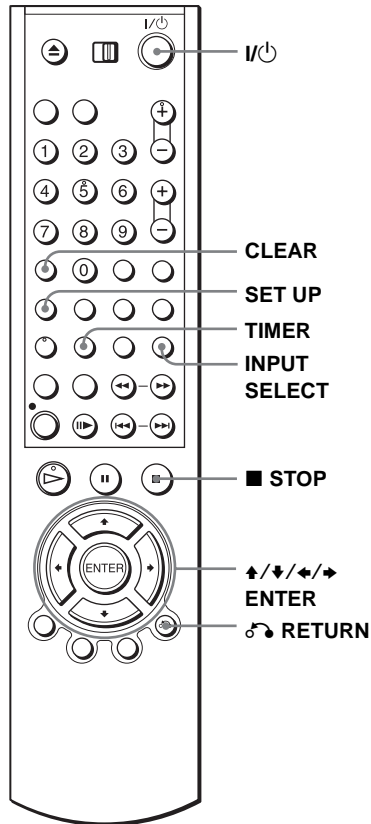

1

SET UP



Press SET UP.

The “**SETUP MENU**” appears.

SUBTITLE/
TIMER



You can also use the **TIMER** button in **VIDEO** mode, then you can skip step 2.

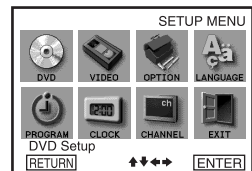

continued

2



Press /// to select (Set Timer Recording), then press ENTER.

The program menu appears.

CH	START	END	DATE	SPD
▶ ---	---	---	---	---
---	---	---	---	---
---	---	---	---	---
---	---	---	---	---
---	---	---	---	---
---	---	---	---	---
---	---	---	---	---
---	---	---	---	---
---	---	---	---	---
---	---	---	---	---
---	---	---	---	---
---	---	---	---	---
---	---	---	---	---
---	---	---	---	---
---	---	---	---	---
---	---	---	---	---
---	---	---	---	---
---	---	---	---	---
---	---	---	---	---

[RETURN] ** **

3



If necessary, press / to select the row that is to be set.

4



Set the channel number, start and stop time, date, and tape speed:

1 Press to flash each item in turn.

2 Press / to set each item.

CH	START	END	DATE	SPD
▶ 35	8:00~	9:00~	9/30	SPD
---	---	---	---	---
---	---	---	---	---
---	---	---	---	---
---	---	---	---	---
---	---	---	---	---
---	---	---	---	---
---	---	---	---	---
---	---	---	---	---
---	---	---	---	---
---	---	---	---	---
---	---	---	---	---
---	---	---	---	---
---	---	---	---	---
---	---	---	---	---
---	---	---	---	---
---	---	---	---	---
---	---	---	---	---
---	---	---	---	---

[RETURN] ** **

To correct a setting, press to return to that setting and reset.



To record from a source connected to the LINE IN 1 or LINE-2 IN jacks, press INPUT SELECT or / to display “L1” or “L2” in the “CH” position.

To record the same program every day or the same day every week, press while the date is flashing. For details, see “Daily/weekly recording” below.

To use the Auto Tape Speed function, press to display “AUTO” in the “SPD” position. For details, see “To use the Auto Tape Speed function” on page 41.

5



Press RETURN to confirm the setting.

The indicator appears in the display window.



To enter another setting, press / to select the next row and repeat step 4.

Press CLEAR repeatedly to cancel the setting.

6



Press RETURN repeatedly to exit the menu.

The DVD-VCR stands by for recording (timer recording will operate properly regardless if the DVD-VCR power is on or off). When using a cable box, leave it on.

To stop recording

To stop the DVD-VCR while recording, press SELECT VIDEO and then press ■ STOP.

Daily/weekly recording

In step 4 above, press ▼ to select the recording pattern. Each time you press ▼, the indication changes as shown below. Press ▲ to change the indication in reverse order.

MO~FR → SUN'S → MON'S → → SAT'S → 1 month later → (dates count down) → the current date

To use the Auto Tape Speed function

When you are recording a program in the AUTO mode and the remaining tape becomes shorter than the recording time, the tape speed is automatically changed to the EP mode. Note that some noise will appear on the picture when the tape speed is changed. If you want to keep the tape speed, select SP. To operate this function, set "Tape Length" in "VIDEO FUNCTION SETUP" menu correctly (page 86).

To watch another TV program after setting the timer

- 1 Press TV/VIDEO to display "TV" in the display window.



- 2 If your TV is connected to the VCR using A/V connections, set the TV to the TV's antenna input; if not, skip this step.
- 3 Select another channel on the TV.

To watch a DVD after setting the timer

- 1 Press SELECT DVD to control the DVD player.
- 2 Press ▲ and place the disc on the disc tray.
- 3 Press ▷ PLAY.

The disc tray closes and the DVD player starts playback. The TV screen will automatically change to the DVD playback screen.

Tips

- To set the channel, you can also use ▲/▼.
- If the □ indicator appears, the timer settings overlap. To check, change or cancel the program setting, repeat the steps of "Recording TV programs using the timer" on page 39.
- If the ○ indicator appears, this means that the VCR is currently recording this program.
- You can also do the following tasks while the VCR is recording:
 - Reset the counter (page 35).
 - Display tape information on the TV screen (page 37).

Checking/changing/canceling timer settings **VHS**

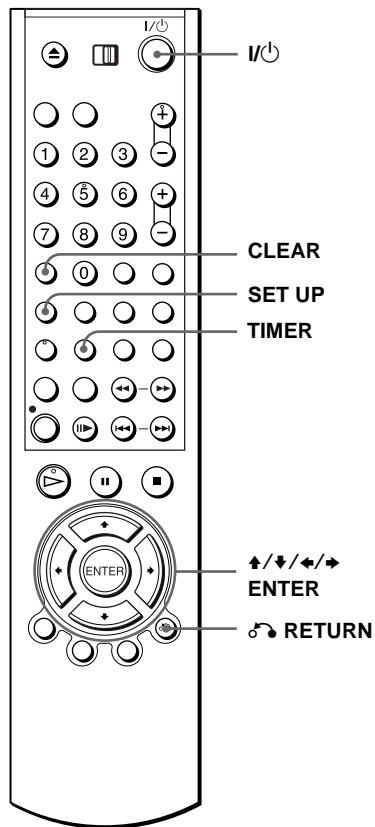

1

SET UP



SUBTITLE/
TIMER



Press SET UP when the DVD player is in stop mode.

The “SETUP MENU” appears.

You can also use the TIMER button in VIDEO mode, then you can skip step 2.

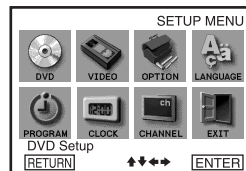

2



RETURN

Press **▲/▼/◀/▶** to select  “Set Timer Recording”, then press ENTER.

- If you want to change a setting, go on to the next step.
- If you do not need to change the settings, press  RETURN repeatedly to exit the menu, then turn off the VCR to return to recording standby.

3



CLEAR



Press **▲/▼** to select setting you want to change or cancel.

- To change the setting, press **◀/▶** to flash the item you want to change, and press **▲/▼** to change it.
- To cancel the setting, press CLEAR.

CH	START	END	DATE	SPD
▶ 35	08:00 ^h	9:00 ^h	9/30	SP
20	10:00 ^h	11:30 ^h	10/02	EP
60	08:30 ^h	10:00 ^h	9/30	AUTO
---	---	---	---	---
---	---	---	---	---
---	---	---	---	---
---	---	---	---	---
---	---	---	---	---
---	---	---	---	---

RETURN ▲▶ ▶▶

4



RETURN

Press  RETURN to confirm the setting.

The  indicator appears in the display window.

5



RETURN

Press  RETURN repeatedly to exit the menu.

The DVD-VCR stands by for recording (you do not have to turn off the DVD-VCR). When using a cable box, leave it on.

When the timer settings overlap

The program that starts first has priority and the second program starts recording only after the first program has finished. If the programs start at the same time, the program listed first in the menu has priority.

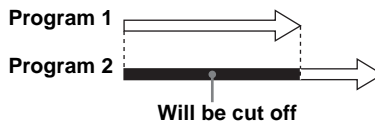

A/V Receiver hookup **DVD** **VCD** **CD** **DATA-CD** **VHS**

A Use this hookup if your A/V receiver has a Dolby* Surround (Pro Logic) decoder and 3 to 6 speakers

You can enjoy the Dolby Surround effects only when playing Dolby Surround audio or multi-channel audio (Dolby Digital) discs.

* Manufactured under license from Dolby Laboratories. "Dolby," "Pro Logic," and the double-D symbol are trademarks of Dolby Laboratories.

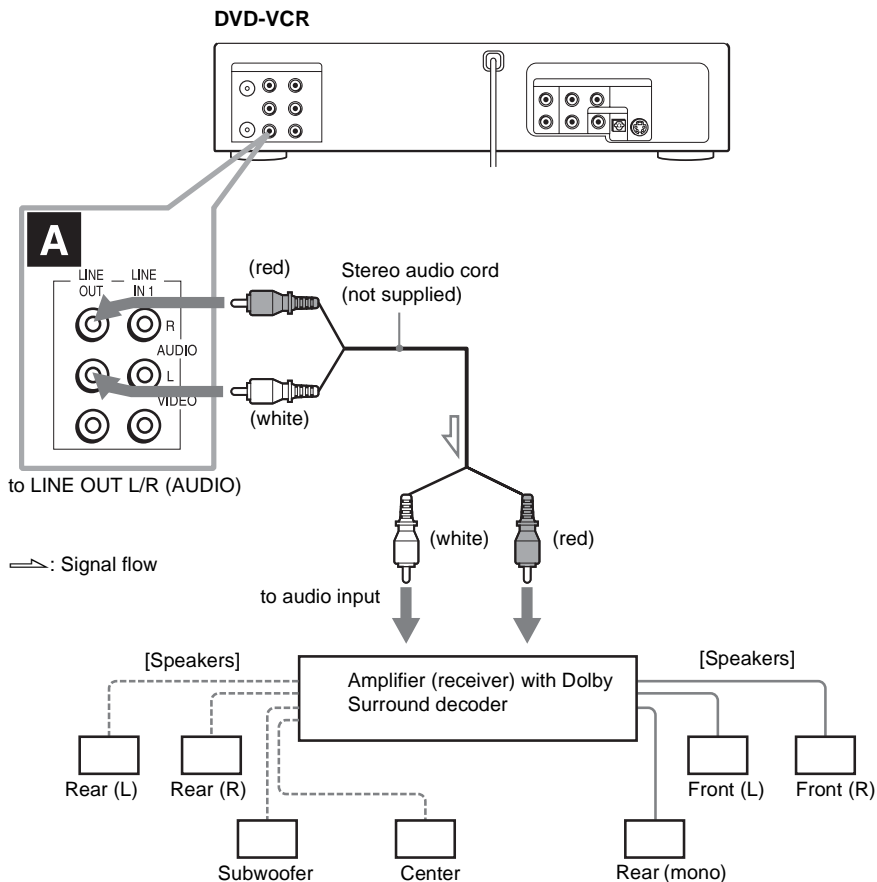

Note

- When connecting 6 speakers, replace the monaural rear speaker with a center speaker, 2 rear speakers and a subwoofer.

B Use this hookup if your A/V receiver has a Dolby Digital or DTS* decoder, a digital input jack and 6 speakers

This connection will allow you to use the Dolby Digital or DTS decoder function of your AV amplifier (receiver). You are not able to enjoy the surround sound effects of this player. You must make connections using **B-1** and **B-2**.

* “DTS” and “DTS Digital Out” are trademarks of Digital Theater Systems, Inc.

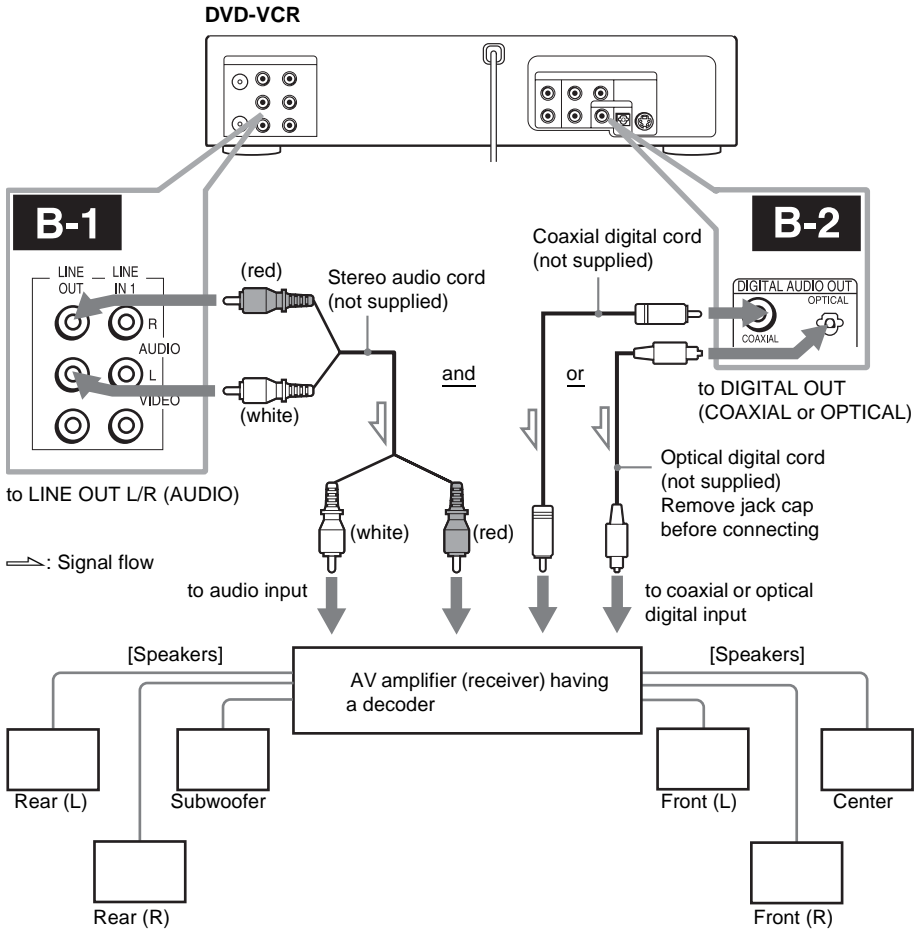

Note

- After you have completed the connection, be sure to set “Dolby Digital” to “Dolby Digital” and “DTS” to “On” in “Audio Setup” (page 48). Otherwise, no sound or a loud noise will come from the speakers.

S-Video/Component Video hookup **DVD** **VCD**

Make audio connections using the LINE OUT AUDIO L/R jacks or DIGITAL AUDIO OUT (OPTICAL or COAXIAL) jacks on the right side of the DVD-VCR when you use S-VIDEO/Component Video hookup.

A Use this hookup if your TV has an S VIDEO input jack

Connect an S VIDEO cord (not supplied). You will enjoy high quality images.

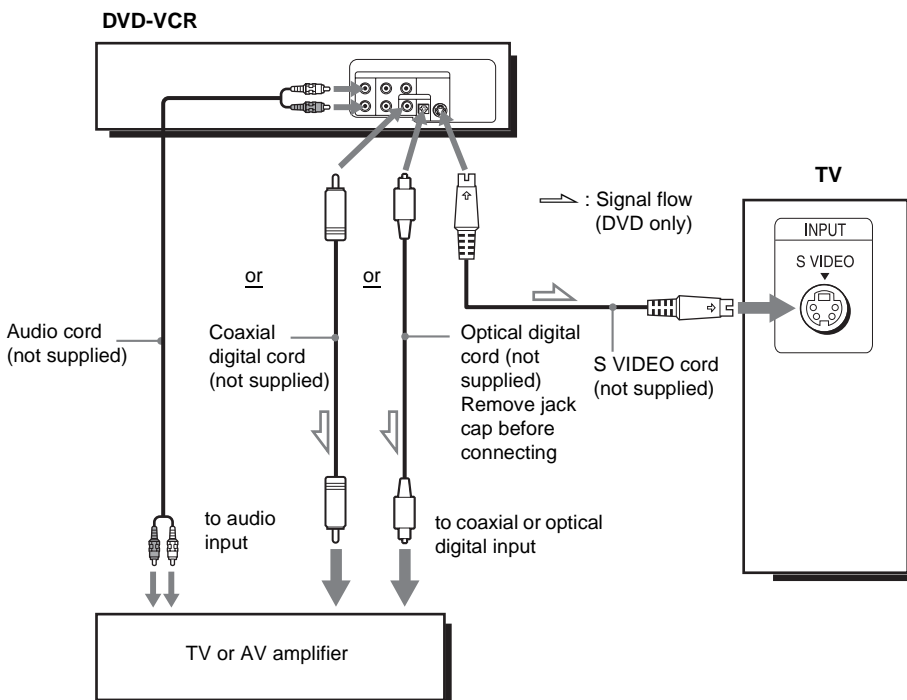

Notes

- Set "Video Out" to "S-Video" in the "SCREEN SETUP" menu (page 51) to view pictures from the S VIDEO jack.
- The connection using S VIDEO OUT jack is only for the DVD player.

B Use this hookup if your TV has component video input jacks

Connect your TV via the COMPONENT VIDEO OUT jacks using a component video cord (not supplied) or three video cords (not supplied) of the same kind and length. You will enjoy accurate color reproduction and high quality images. See page 46 for audio connections.

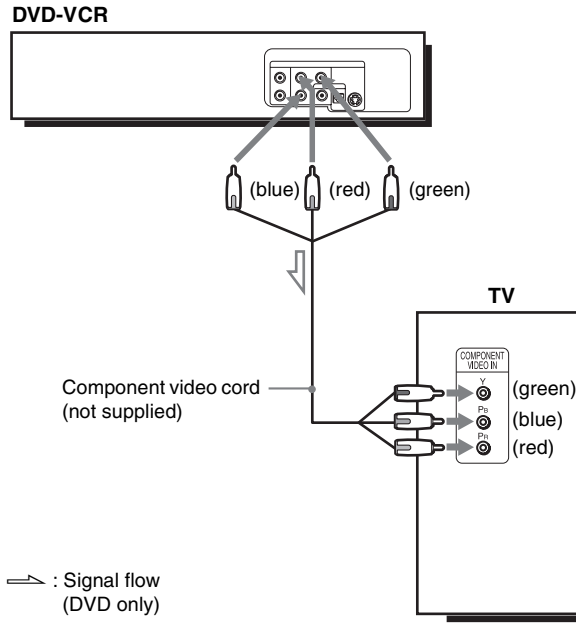

If your TV accepts progressive (480p) format signals, you must use this connection and then press the **PROGRESSIVE** button on the front panel when the DVD player is in stop mode to accept progressive video signals. The **PROGRESSIVE** indicator lights up in blue when the DVD player outputs progressive signals.

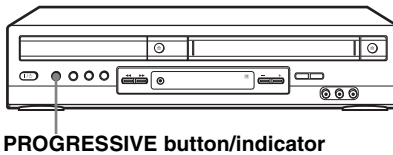



Notes

- Set "Video Out" to "Component" in the "SCREEN SETUP" menu (page 51) to view pictures from the component video jacks.
- The connection using COMPONENT VIDEO OUT jack is only for the DVD player.
- The PROGRESSIVE button is not available when the DVD player is in play mode. Use the PROGRESSIVE button in stop mode.

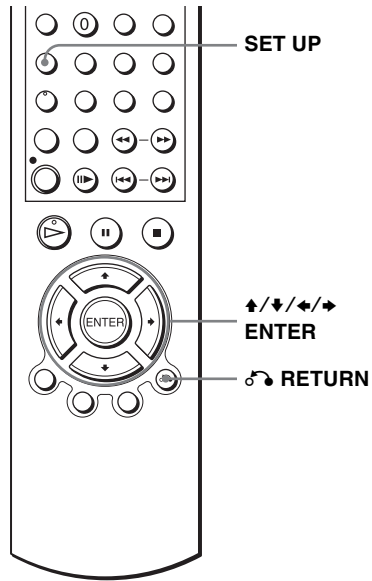

Audio Setup DVD

“Audio Setup” allows you to set the sound according to the playback and connection conditions.



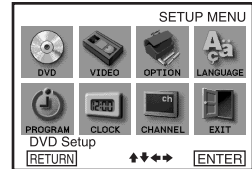

- 1  Press SET UP when the DVD player is in stop mode.
The “SETUP MENU” appears.

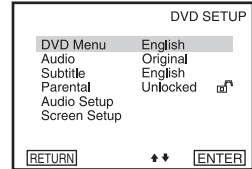

- 2  Press  to select  (DVD Setup), then press ENTER.
The “DVD SETUP” menu appears.



- 3  Press  to select “Audio Setup,” then press ENTER.

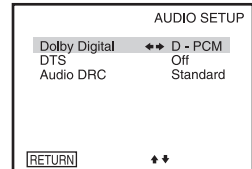

4



Press **↑/↓** to select the setup item from the displayed list: “Dolby Digital,” “DTS,” or “Audio DRC.”

5



Press **←/→** to select an item, then press **↻** RETURN to confirm the setting.



RETURN

6



Press **↻** RETURN repeatedly to exit the menu.

RETURN

Menu choices

- **Dolby Digital** (DVD only)

Selects the type of Dolby Digital signal.

The default setting is indicated in bold print.

D-PCM	Select this when the player is connected to an audio component lacking a built-in Dolby Digital decoder.
Dolby Digital	Select this when the player is connected to an audio component with a built-in Dolby Digital decoder.

- **DTS** (DVD only)

Selects whether or not to output DTS signals.

The default setting is indicated in bold print.

Off	Select this when the player is connected to an audio component lacking a built-in DTS decoder.
On	Select this when the player is connected to an audio component with a built-in DTS decoder.

- **Audio DRC** (Dynamic Range Control) (DVD only)

Makes the sound clear when the volume is turned down when playing a DVD that conforms to “Audio DRC.” This affects the output from the following jacks:

- LINE OUT AUDIO L/R jacks
- DIGITAL AUDIO OUT (OPTICAL or COAXIAL) jack only when “Dolby Digital” is set to “D-PCM”.

The default setting is indicated in bold print.

Standard	Normally select this position.
TV Mode	Makes the low sounds clear even if you turn the volume down.

continued

Notes

- If you select surround setting while playing a DVD, the player does not output Dolby Digital signals from the DIGITAL AUDIO OUT (OPTICAL or COAXIAL) jack (when you set “Dolby Digital” to “D-PCM”).
- If you connect a component that does not conform to the selected audio signal, a loud noise (or no sound) will come out from the speakers, affecting your ears or causing the speakers to be damaged.

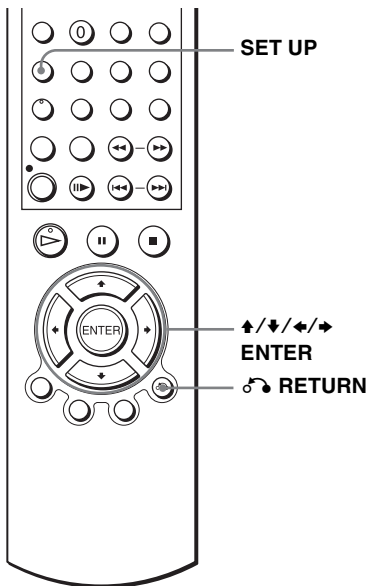

Screen Setup **DVD**

“Screen Setup” allows you to set the screen according to the playback and connection conditions.

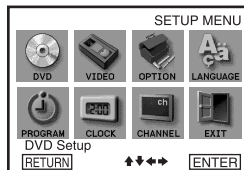

- 1**  Press SET UP when the DVD player is in stop mode.
The “SETUP MENU” appears.



- 2**  Press $\uparrow/\downarrow/\leftarrow/\rightarrow$ to select  (DVD Setup), then press ENTER.
The “DVD SETUP” menu appears.

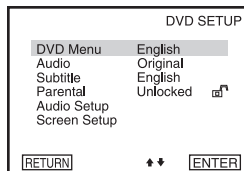

- 3**  Press \uparrow/\downarrow to select “Screen Setup,” then press ENTER.

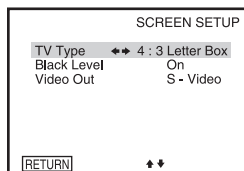

continued

4



Press **▲/▼** to select the setup item from the displayed list: “TV Type,” “Black Level,” or “Video Out.”

5



Press **←/→** to select an item, then press **↶** RETURN to confirm the setting.



RETURN

6



Press **↶** RETURN repeatedly to exit the menu.

RETURN

Menu choices

- TV Type

Selects the aspect ratio of the connected TV (4:3 standard or wide). The default setting is indicated in bold print.

4:3 Letter Box	Select this when you connect a 4:3 screen TV. Displays a wide picture with bands on the upper and lower portions of the screen.
4:3 Pan Scan	Select this when you connect a 4:3 screen TV. Automatically displays the wide picture on the entire screen and cuts off the portions that do not fit.
16:9	Select this when you connect a wide-screen TV or a TV with a wide mode function.

4:3 Letter Box



4:3 Pan Scan



16:9



- Black Level

You can enhance the black level by increasing the brightness and contrast when viewing DVDs with the PROGRESSIVE indicator turned off. The default setting is indicated in bold print.

On	Increases the contrast.
Off	Stops the increase of the contrast.

- Video Out

You must set this setting when you use S VIDEO OUT or COMPONENT VIDEO OUT jacks to connect to the TV.

The default setting is indicated in bold print.

S-Video	Select this when you use the S VIDEO OUT jack on the rear panel to connect to the TV.
Component	Select this when you use the COMPONENT VIDEO OUT jacks on the rear panel to connect to the TV.

Tip

- You can select the type of signal output from the COMPONENT VIDEO OUT jacks. When you press the PROGRESSIVE button on the front panel when the DVD player is in stop mode, progressive signal is selected and the PROGRESSIVE indicator lights up in blue. Select this when you have a TV that can accept progressive signal. When you are connected to a standard (interlace format) TV, turn off the PROGRESSIVE indicator.

Notes

- Playback settings stored in the disc take priority over the “DVD SETUP” menu settings and not all the functions described may work.
- Depending on the DVD, “4:3 Letter Box” may be selected automatically instead of “4:3 Pan Scan” or vice versa.
- The connection using S VIDEO OUT or COMPONENT VIDEO OUT jacks is only for the DVD player.
- If you select progressive signal when you connect the DVD player to a TV that cannot accept the signal in progressive format, the image quality will deteriorate. In this case, press the PROGRESSIVE button to turn off the PROGRESSIVE indicator.
- You can output progressive signal only from COMPONENT VIDEO OUT jacks. If you turn on the PROGRESSIVE indicator when you set “Video Out” to “S-video”, COMPONENT VIDEO OUT takes priority over S VIDEO OUT.
- The PROGRESSIVE button is not available when the DVD player is in play mode. Use the PROGRESSIVE button in stop mode.

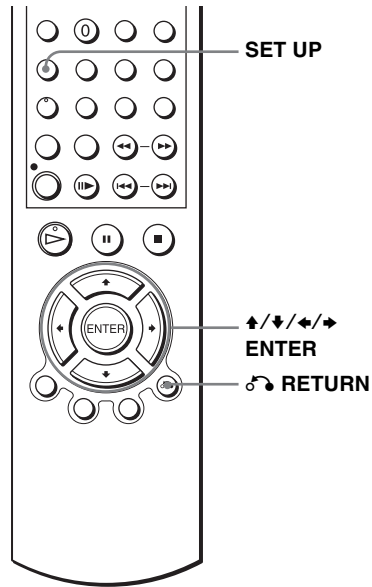

Setting the display or sound track language **DVD**

You can set various languages for the disc's menu, sound track or subtitle.

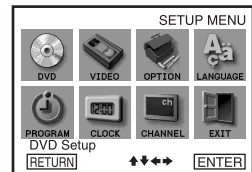

- 1**  Press **SET UP** when the DVD player is in stop mode.
The “**SETUP MENU**” appears.



- 2**  Press **↑/↓/←/→** to select  (DVD Setup), then press **ENTER**.
The “**DVD SETUP**” menu appears.

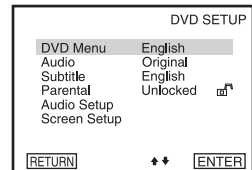

- 3**  Press **↑/↓** to select the language setup item from the displayed list: “**DVD Menu,**” “**Audio,**” or “**Subtitle.**”
Then press **ENTER**.

4



Press \uparrow/\downarrow to select the desired language, then press ENTER.

- **DVD MENU LANGUAGE**
You can select the desired language for the disc's menu.

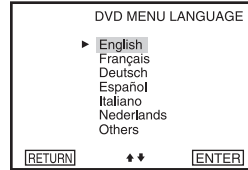

- **AUDIO LANGUAGE**
Switches the language of the sound track. When you select "Original," the language given priority in the disc is selected.

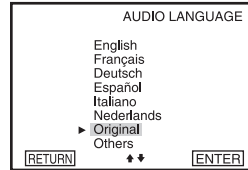

- **SUBTITLE LANGUAGE**
Switches the language of the subtitle recorded on the DVD.

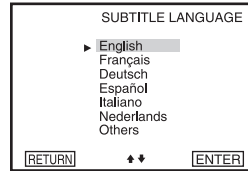

5



RETURN

Press \circlearrowleft RETURN repeatedly to exit the menu.

Tip

If you select "Others" in step 4, an additional language menu appears. Press $\uparrow/\downarrow/\leftarrow/\rightarrow$ to select the desired language, then press ENTER.



Notes

- When you select a language that is not recorded on the DVD in step 4, one of the recorded languages will be automatically selected.
- Playback settings stored in the disc take priority over the DVD SETUP settings and not all the functions described may work.

Parental Control (limiting playback by children)

DVD

Playback of some DVDs can be limited according to a predetermined level such as the age of the users. The “PARENTAL CONTROL” function allows you to set a playback limitation level.

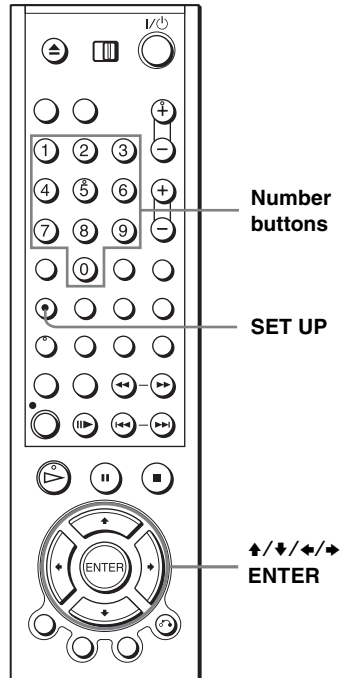

1

SET UP



Press SET UP when the DVD player is in stop mode.

The “SETUP MENU” appears.

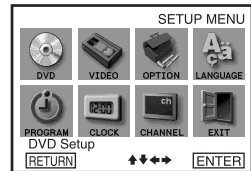

2



Press $\uparrow/\downarrow/\leftarrow/\rightarrow$ to select  (DVD Setup), then press ENTER.

The “DVD SETUP” menu appears.

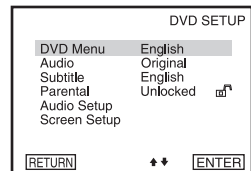

3



Press \uparrow/\downarrow to select "Parental," then press ENTER.

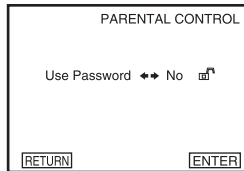

4



Press \rightarrow to select "Yes".

- If you have not entered a password
The display for registering a new password appears.
Enter a 4-digit password using the number buttons.

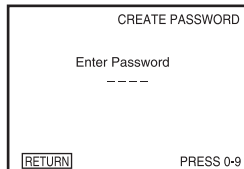

The display for confirming the password appears.
Re-enter the password.

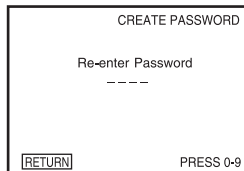

- When you have already registered a password
The display for entering the password appears.
Enter a 4-digit password using the number buttons.

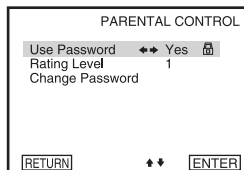
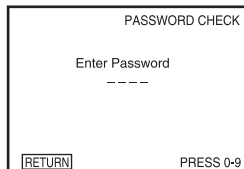

5



Press \uparrow/\downarrow to select "Rating Level," then press ENTER.

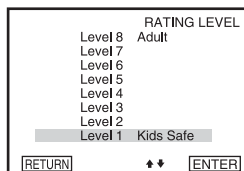

continued

6

Press \uparrow/\downarrow to select the level you want, then press ENTER.

The options are as follows.

Level 8 (Adult) \leftrightarrow Level 7 \leftrightarrow Level 6 \leftrightarrow
 Level 5 \leftrightarrow Level 4 \leftrightarrow Level 3 \leftrightarrow Level 2
 \leftrightarrow Level 1 (Kids Safe)

The lower the value, the stricter the limitation.

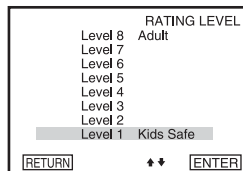
**7**

RETURN

Press \curvearrowright RETURN repeatedly to exit the menu.

To change the password

- 1** Select “Change Password” in step 4.
The display for entering a new password appears.
- 2** Enter a new 4-digit password using the number buttons.
The display for confirming the password appears.
- 3** Re-enter the new password.

To turn off the Parental Control function

Set “Use Password” to “No” in Step 4.

To play a disc for which Parental Control is set

- 1** Insert the disc, then press \triangleright PLAY.
The display for entering your password appears.
- 2** Enter your 4-digit password using the number buttons.
The player starts playback.

If you forget your password

- 1** Remove the disc and turn off the DVD-VCR.
- 2** Turn on the DVD-VCR again with no disc in the unit.
- 3** Hold down \lll and \ggg on the front panel simultaneously for 5 seconds.
“reset ok” appears on the screen.
- 4** Turn off the DVD-VCR.
The password is cleared.
- 5** To create a new password, follow step 4 on page 57.

Notes

- When you play DVDs which do not have the Parental Control function, playback cannot be limited on this player.
- All the ratings higher than the level you select will be blocked.
- Write your password down and keep it in a safe place in case you forget it.



Using the DVD's menu DVD

A DVD is divided into long sections of a picture or a music feature called "titles." When you play a DVD which contains several titles, you can select the title you want using the TOP MENU button.

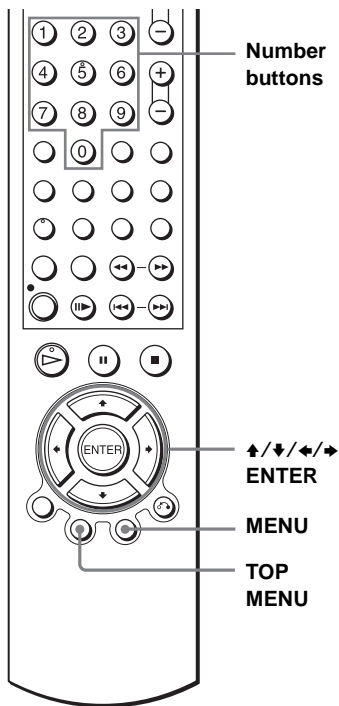



When you play DVDs that allow you to select items such as the language for the subtitles and the language for the sound, select these items using the MENU button.



- 1**

 Press TOP MENU or MENU.
 The disc's menu appears on the TV screen.
 The contents of the menu vary from disc to disc.

- 2**

 Press /// to select the item you want to play or change.
 You can also use the number buttons to select the item.

- 3**

 Press ENTER.

Note

- Depending on the DVD, you may not be able to use the TOP MENU button.

Zooming into a scene **DVD** **VCD** **DATA-CD**

You can zoom into a scene during playback or still mode. To zoom into a JPEG image, see “Playing JPEG image files” on page 76.

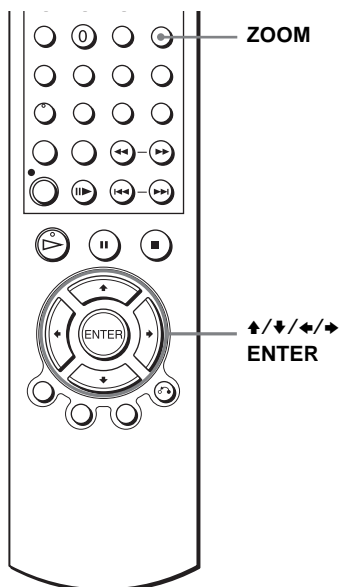

1



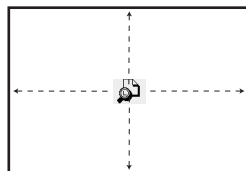

Press ZOOM.

“” appears.



2



Press  to move “” to the position where you want to zoom in.

3



Press ENTER repeatedly to change the magnification.

Each time you press the button, the magnification changes as shown below.

2× → 4× → 2× → normal magnification

Notes

- You cannot use 4× magnification when you play VIDEO CDs.
- The zoom function may not work depending on the DVD.

Changing the angles **DVD**

If various angles (multi-angles) for a scene are recorded on the DVD, “” appears in the display when you press ANGLE during playback. This means that you can change the viewing angle.

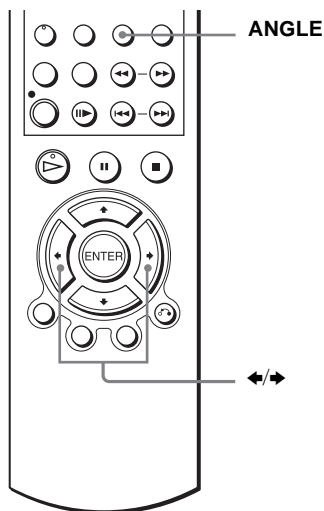

1

ANGLE



Press ANGLE during playback.

The angle number appears on the display.

The number after the slash indicates the total number of angles.

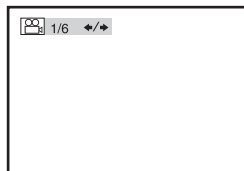

2



Press  repeatedly to select the angle number.

The scene changes to the selected angle.

Note

- Depending on the DVD, you may not be able to change the angles even if multi-angles are recorded on the DVD.

Displaying the subtitle **DVD**

If subtitles are recorded on the disc, you can change the subtitles or turn them on and off whenever you want while playing a DVD.

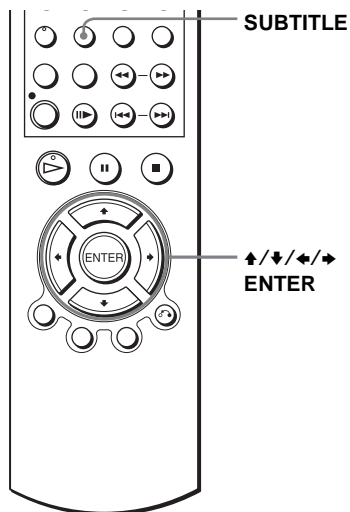

1 Press SUBTITLE during playback.

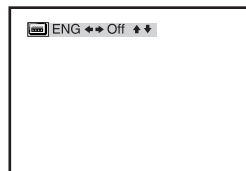

2 Press \leftarrow/\rightarrow repeatedly to select the language.



Depending on the DVD, the choice of language varies. Refer to "DVD Audio/Subtitle Language" on page 106 for the abbreviation of the language.

3 Press \uparrow/\downarrow repeatedly to select "On."



To turn off the subtitles

Select "Off" in step 3.

Note

- Depending on the DVD, you may not be able to change the subtitles even if multilingual subtitles are recorded on it. You also may not be able to turn them off.

Various play mode functions (Program play, Shuffle play, Repeat play) **DVD** **VCD** **CD** **DATA-CD**

You can set the following play modes:

- Program play (page 63)
- Shuffle play (page 65)
- Repeat play (page 66)

Note

- The play mode is canceled when:
 - you open the disc tray
 - the player enters standby mode by pressing I/⏻.

Creating your own program (Program play) **CD**

You can play the contents of a disc in the order you want by arranging the order of the tracks on the disc to create your own program. You can program up to 20 tracks.

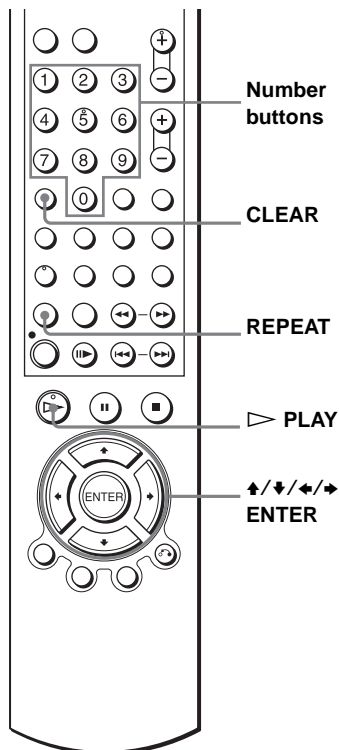

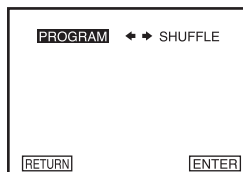

continued

- 1**  Press REPEAT when the DVD player is in stop mode.

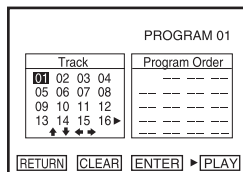

- 2**  Press ←/→ to select “PROGRAM”, then press ENTER.



- 3**  Press ↑/↓/←/→ to select the track number you want to program, then press ENTER.
You can also use the number buttons to enter the track number.

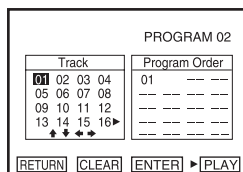

- 4** To program other tracks, repeat step 3.
The programmed track numbers are displayed in the selected order.

- 5**  Press ▷ PLAY to start program play.
Program play starts.
When the program ends, you can restart the same program again by pressing ▷ PLAY.

To stop program play

Press CLEAR.

To change or cancel a program

- 1 Follow steps 1 and 2 of “Creating your own program (Program play).”
- 2 Press CLEAR.
The last programmed number is canceled.
- 3 Follow step 3 for new programming.

Playing in random order (Shuffle play) **CD**

You can shuffle the playback order of tracks. Subsequent “shuffling” may produce a different playing order.

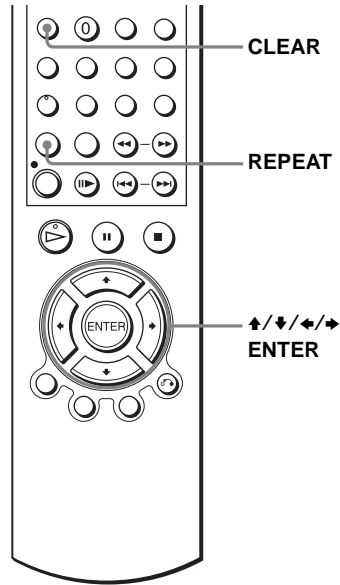

1

REPEAT/
REPLAY



Press REPEAT when the DVD player is in stop mode.

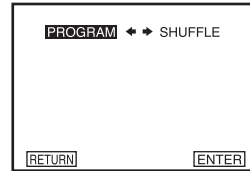

2



Press \leftarrow/\rightarrow to select “SHUFFLE”, then press ENTER.

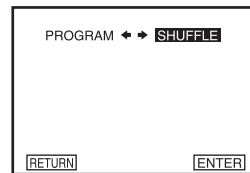

To return to normal play

Press CLEAR.

Tip

- When “SHUFFLE” is selected, shuffle play will continue until cancelled.

Playing repeatedly (Repeat play) **DVD** **VCD** **CD** **DATA-CD**

You can play all of the titles or tracks on a disc or a single title, chapter, or track repeatedly.

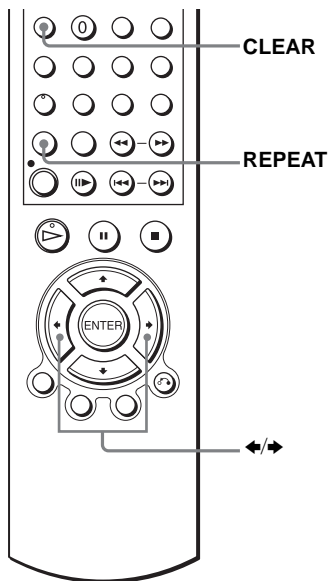

1



Press REPEAT during playback.

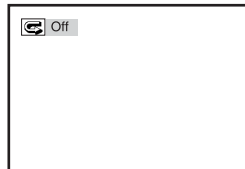

2



Press REPEAT or  repeatedly to select the item to be repeated.



When playing a DVD

- Chapter: repeats the current chapter.
- Title: repeats the current title on a disc.

When playing a VIDEO CD or CD

- Track: repeats the current track.
- Disc: repeats all of the tracks.

When playing a DATA CD (MP3 audio)

- Track: repeats the current track.

To return to normal play

Select "Off" or press CLEAR in step 2.

Using bookmarks **DVD** **VCD**

You can store scenes in the player's memory as bookmarks.

You can set up to three bookmarks.

Select "MENU OFF" before setting up bookmarks on a VIDEO CD (see "Playing VIDEO CDs with "MENU ON/OFF" Functions" on page 79).

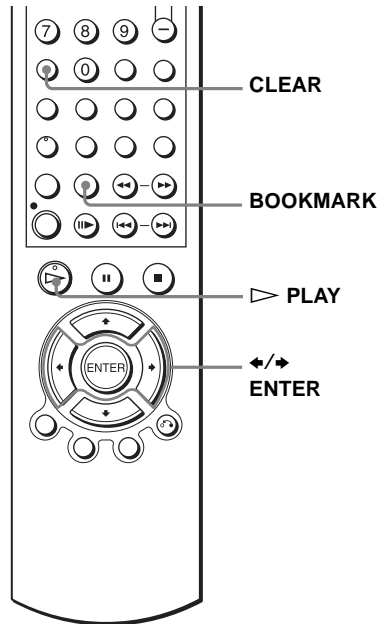

- 1** **BOOKMARK/SEARCH MENU** Press **BOOKMARK** during playback. Three bookmark placeholders (---) appear next to the bookmark icon.

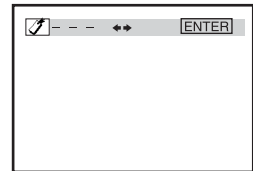

- 2** Press **↔** to select one of the placeholders.



- 3** Play the DVD scene you want, then press **ENTER**. The selected placeholder changes to a number (1, 2 or 3).

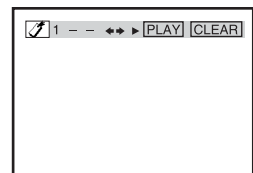

continued

To cancel the bookmark

Press CLEAR after step 3.

To exit the Bookmark menu

Press BOOKMARK.

To playback the scene where you insert a bookmark

1 Press BOOKMARK during playback.

2 Press ◀/▶ to select the bookmark placeholder, then press ▷ PLAY to play the bookmark.

Note

- Depending on the DVD, you may not be able to use the bookmark function.

Changing the sound **DVD** **VCD** **CD**

When playing a DVD recorded in multiple audio formats (PCM, Dolby Digital, or DTS), you can change the audio format. If the DVD is recorded with multilingual tracks, you can also change the language.

With CDs, DATA CDs, or VIDEO CDs, you can select the sound from the right or left channel and listen to the sound of the selected channel through both the right and left speakers. For example, when playing a disc containing a song with the vocals on the right channel and the instruments on the left channel, you can hear the instruments from both speakers by selecting the left channel.

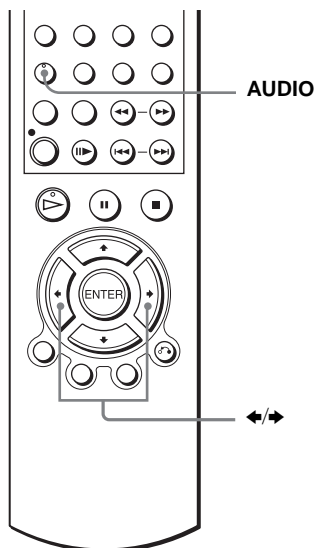

- 1** **AUDIO** Press **AUDIO** during playback.

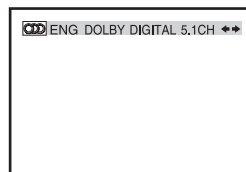

- 2** Press **↔** repeatedly to select the desired language/audio setting.



- When playing a DVD
Depending on the DVD, the choice of language varies. Refer to “DVD Audio/Subtitle Language” on page 106 for the abbreviation of the language.
- When playing a VIDEO CD or CD
The default setting is indicated in bold print.

STEREO	The standard stereo sound
Left	The sound of the left channel (monaural)
Right	The sound of the right channel (monaural)

Virtual surround setting **DVD**

When you connect a stereo TV or 2 front speakers, SURROUND lets you enjoy surround sound effects by using sound imaging to create virtual rear speakers from the sound of the front speakers without using actual rear speakers. This function is designed to work with the LINE OUT AUDIO L/R jacks.

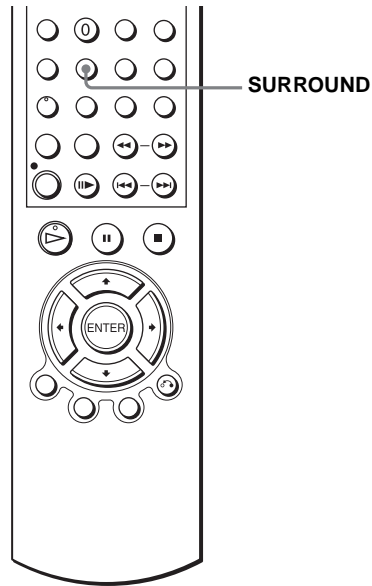

-
- 1** SURROUND Press SURROUND during playback.

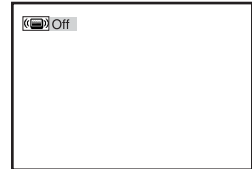

-
- 2** SURROUND Press SURROUND repeatedly to select "On."



To cancel the setting

Select "Off" in step 2.



Notes

- When the playing signal does not contain a signal for the rear speakers, the surround effects will be difficult to hear.
- When you activate the surround effect, turn off the surround setting of the connected TV or amplifier (receiver).
- Make sure that your listening position is between and at an equal distance from your speakers, and that the speakers are located in similar surroundings.
- If you use the DIGITAL AUDIO OUT (OPTICAL or COAXIAL) jack and set “Dolby Digital” to “Dolby Digital” or “DTS” to “On” in “AUDIO SETUP” menu, sound will come from your speakers but it will not have the surround effect.
- Certain audio features of this product manufactured under a license from Desper Products, Inc. Spatializer®, VBXTM and the circle-in-square device are trademarks owned by Desper Products, Inc.

Playing an MP3 audio track **DATA-CD**

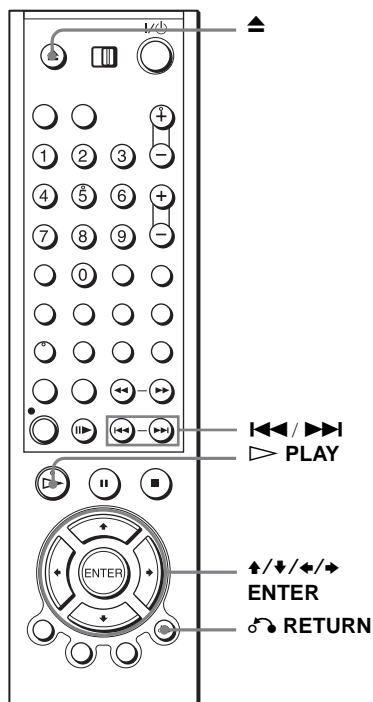
You can play back DATA CDs (CD-ROMs/CD-Rs/CD-RWs) recorded in MP3 (MPEG1 Audio Layer 3) format.





- 1**  Press  and place a DATA CD on the disc tray, then press  to close the tray.

When you load a DATA CD which contains MP3 audio tracks and JPEG image files, "Select a Media Type" menu appears.

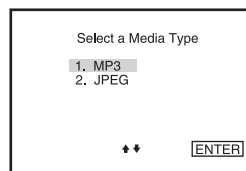
If you load a DATA CD which contains only MP3 audio files, the MP3 display appears. Then you can skip step 2.



- 2**  Press  to select "MP3", then press ENTER.

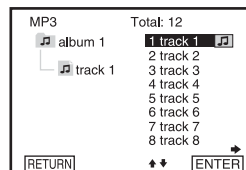

3



Press **▲/▼** or **◀◀/▶▶** to select the desired track, then press **ENTER**.

The selected track starts playing.

When a track or album is being played, its title is shaded. The playing track number appears on the display window.



4



RETURN

To change the album, press **↻** RETURN.

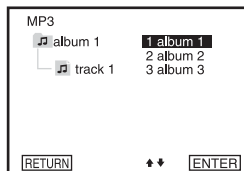

5



Press **▲/▼** to select an album, then press **ENTER**.

The list of tracks contained in the album appears.

To select a track, repeat step 2.

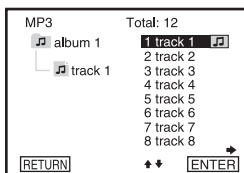

To go to the next or previous page

Press **➡** or **⬅**.

To return to the previous display

Press **↻** RETURN.

To return to the “Select a Media Type” menu

Press **■** STOP twice, then press **TOP MENU**.

To turn off the display

Press **■** STOP, then press **↻** RETURN repeatedly.

Notes

- Only the letters in the alphabet and numbers can be used for album or track names. Anything else is displayed as an asterisk.
- Up to 10 alphanumeric characters can be displayed for album or track names.
- ID3 tags cannot be displayed.

continued

About MP3 audio tracks

You can play MP3 audio tracks on CD-ROMs, CD-Rs, or CD-RWs. However, the discs must be recorded according to ISO9660 level 1, level 2, or Joliet format for the player to recognize the tracks.

You can also play discs recorded in Multi Session.

See the instructions of the CD-R/RW device or recording software (not supplied) for details on the recording format.

To play a Multi Session CD

This player can play Multi Session CDs when an MP3 audio track is located in the first session. Any subsequent MP3 audio tracks, recorded in the later sessions, can also be played back. When audio tracks and images in music CD format or video CD format are recorded in the first session, only the first session will be played back.

Notes

- If you put the extension “.MP3” to data not in MP3 format, the player cannot recognize the data properly and will generate a loud noise which could damage your speaker system.
- The player cannot play audio tracks in MP3PRO format.
- This player supports MP3 audio tracks recorded with a bit rate of 128 kbps and a sampling frequency of 44.1 kHz. Attempting to play MP3 audio tracks recorded with different specifications may result in loud noise, sound skipping or speaker damage.
- Depending on the disc, playback may take some time to start.

The Playback order of MP3 audio tracks

The playback order of albums and tracks recorded on a DATA CD is as follows.

- Structure of disc contents

Tree 1 Tree 2 Tree 3 Tree 4 Tree 5

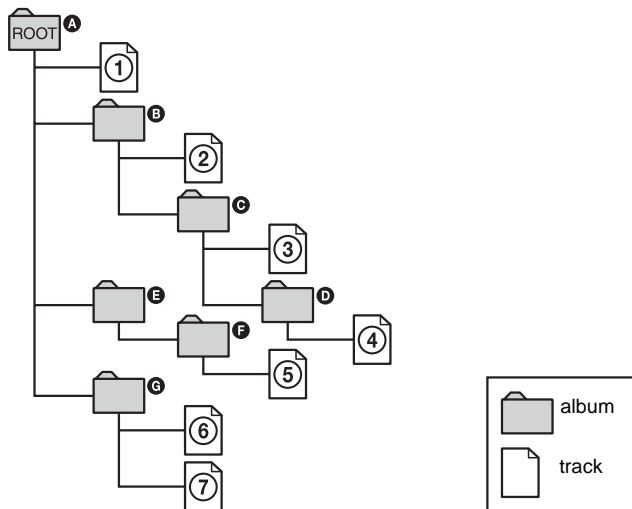

When you insert a DATA CD and press \triangleright PLAY, the numbered tracks are played sequentially, from ① through ⑦. Any sub-albums/tracks contained within a currently selected album take priority over the next album in the same tree. (Example: **C** contains **D** so ④ is played before ⑤.)

When you press \curvearrowright RETURN and the list of MP3 albums appears (page 73), the albums are arranged in the following order: **A** \rightarrow **B** \rightarrow **C** \rightarrow **D** \rightarrow **F** \rightarrow **G**. Albums that do not contain tracks (such as album **E**) do not appear in the list.

Tips

- If you add numbers (01, 02, 03, etc.) to the front of the track file names, the tracks will be played in that order.
- A disc with many trees takes longer to start playback. Some discs with many trees cannot be played back.

Notes

- Depending on the software you use to create the DATA CD, the playback order may differ from the illustration above.
- The playback order above may not be applicable if there are more than a total of 200 albums and tracks in the DATA CD.
- The player can recognize up to 100 albums (the player will count just albums, including albums that do not contain MP3 audio tracks). The player will not play any albums beyond the first 100 albums. Of the first 100 albums, the player will play no more than a combined total of 200 albums and tracks.

Playing JPEG image files DATA-CD

You can play JPEG image files on DATA CDs (CD-ROMs/CD-Rs/CD-RWs).

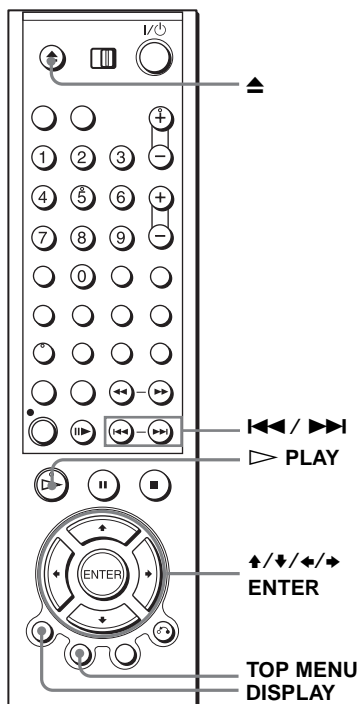

1



Press and place a DATA CD on the disc tray, then press to close the tray.

When you load a DATA CD which contains MP3 audio tracks and JPEG image files, "Select a Media Type" menu appears.

If you load a DATA CD which contains only JPEG image files, the ALBUM display appears. Then you can skip step 2.

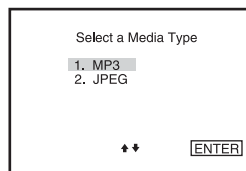

2



Press to select "JPEG", then press ENTER.

The ALBUM display will appear.

To display the total number of JPEG image files on the disc, press DISPLAY.



DISPLAY

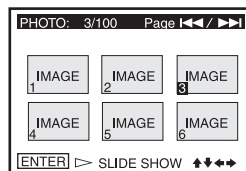

3



Press ◀◀/▶▶ to select the next/previous ALBUM page, press ▲/▼/◀/▶ to select an image in the ALBUM display, then press ▷ PLAY.



The TIMER menu appears.



PLAY



4



Press ◀/▶ to select the desired play speed, then press ENTER. Slide show starts from the selected image.

To display an image

- 1 Press ▲/▼/◀/▶ to select an image in the ALBUM display, then press ENTER. The selected image number appears in the display window.

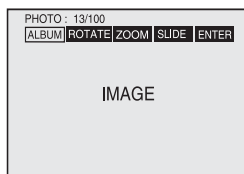



- 2 To display the next/previous image, press ◀◀/▶▶.

To rotate an image

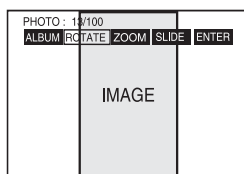
- 1 Press ▲/▼/◀/▶ to select an image in the ALBUM display, then press ENTER.
- 2 Press ◀/▶ to select ROTATE, then press ENTER. Each time you press ENTER, the image turns clockwise by 90°.



To zoom in an image

- 1 Press ▲/▼/◀/▶ to select an image in the ALBUM display, then press ENTER.
- 2 Press ◀/▶ to select ZOOM, then press ENTER. “” appears.
- 3 Press ▲/▼/◀/▶ to move “” to the position where you want to zoom in.
- 4 Press ENTER repeatedly to change the magnification. Each time you press ENTER, the magnification changes as shown below.
2× → 4× → 2× → normal magnification



continued

To enjoy the Slide show

- 1 Press **↑/↓/←/→** to select an image in the ALBUM display, then press ENTER.
- 2 Press **←/→** to select SLIDE, then press ENTER. The TIMER menu appears.
- 3 Press **←/→** to select the desired play speed, then press ENTER. Slide show starts.



To turn on/off the menu in the single image display

Press DISPLAY in the single image display.

To turn on/off the total number of images in the ALBUM display

Press DISPLAY in the ALBUM display.

To return to the ALBUM display

Press DISPLAY to turn on the menu and press **←/→** to select ALBUM, then press ENTER. You can also use MENU button to return to the ALBUM display. Press **◀◀** repeatedly to return to the first ALBUM page.

To return to the “Select a Media Type” menu

Press **■ STOP** twice, then press TOP MENU.

Notes

- Slide show can play in only one direction.
- You cannot rotate or zoom in the image during Slide show.
- If you select ALBUM in the rotated image display, the images in the ALBUM display will also be rotated. Correct the rotation in the ROTATE menu.

About JPEG image files

You can play JPEG image files on CD-ROMs, CD-Rs, or CD-RWs. However, the discs must be recorded according to ISO9660 level 1, level 2, or Joliet format for the player to recognize the files.

You can also play discs recorded in Multi Session.

See the instructions of the CD-R/RW device or recording software (not supplied) for details on the recording format.

To play a Multi Session CD

This player can play Multi Session CDs when a JPEG image file is located in the first session. Any subsequent JPEG image files, recorded in the later sessions, can also be played back. When audio tracks and images in music CD format or video CD format are recorded in the first session, only the first session will be played back.

Notes

- The system can play the extension “.JPG” or “.JPEG.”
- Some CD-Rs or CD-RWs cannot be played on this system depending on file format.
- If you add the extension “.JPG” or “.JPEG” to data not in JPEG format, the display will be blank.
- Depending on the disc or the size of image files, playback may take some time to start.

Tip

- If you add numbers (01, 02, 03, etc.) to the front of the file names, the files will be played in that order.

Playing VIDEO CDs with “MENU ON/OFF” Functions **VCD**

The PBC (Playback control) function allows you to search and perform other operations interactively. PBC playback follows a selection menu displayed on your TV screen.

The “MENU ON” function is the PBC function.

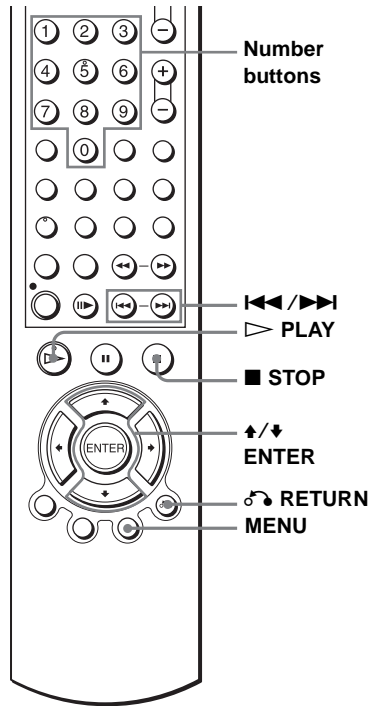

1  Press MENU to select “MENU ON.”
The menu for your selection appears.

2  Press **↑/↓** to select the item number you want.
You can also use the number buttons to select the item number and track.

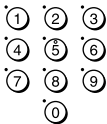

continued

3



Press ENTER.

4

Follow the instructions in the menu for interactive operations.

Refer to the instructions supplied with the disc, as the operating procedure may differ depending on the VIDEO CD.

To return to the menu

Press  RETURN.

To play using “MENU OFF”

Press MENU to select “MENU OFF.”

When “MENU OFF” is selected, the DVD player starts continuous play. You cannot play still pictures such as a menu.

To return to “MENU ON,” press MENU to select “MENU ON.”

Note

- Depending on the VIDEO CD, “Press ENTER” in step 3 may appear as “Press SELECT” in the instructions supplied with the disc. In this case, press  PLAY.

Quick Timer Recording **VHS**

After you have started recording, you can have the VCR stop recording automatically after a specified duration.

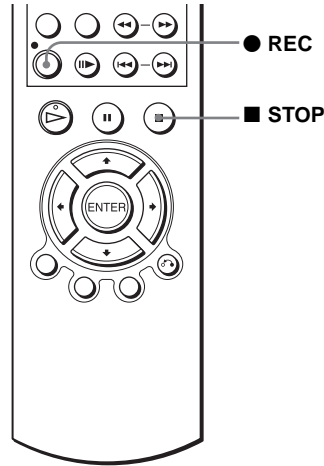

1 While recording, press ● REC.



2 Press ● REC repeatedly to set the duration time.
Each press advances the time as follows.

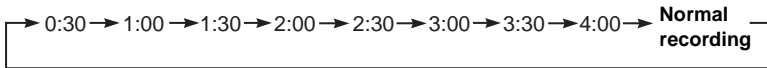

The tape counter decreases minute by minute to 0:00, then the VCR stops recording.

To extend the duration

Press ● REC repeatedly to set a new duration time.

To cancel the duration

Press ● REC repeatedly until the ⊖ indicator disappears and the VCR returns to normal recording mode.

To stop while recording

Press ■ STOP.

Note

- You cannot display the current tape time in the display window when setting the recording duration time.

Recording stereo and bilingual programs

VHS

Recording stereo programs

When you receive a program broadcast in stereo, press AUDIO to display “Hi-Fi” on the TV screen. You can also select “Left,” “Right,” or “Mono.” If there is noise in the stereo program, select “Mono.” The sound will be recorded in monaural (on both hi-fi and normal audio tracks) but with less noise.

Recording bilingual programs

Press AUDIO to display “SAP” on the TV screen. When a SAP (Second Audio Program) is received, “SAP” appears on the TV screen. When MAIN is selected, the VCR records only the main sound.

Selecting the sound during playback

During playback, press AUDIO to select the sound you want.

To listen to	On-screen display	Display window
Stereo	Hi-Fi	STEREO indicator
Left channel	Left	STEREO indicator
Right channel	Right	STEREO indicator
Monaural sound on the normal audio track	Mono	No indicator

How sound is recorded on a video tape

The VCR records sound onto two separate tracks. Hi-fi audio is recorded onto the main track along with the picture. Monaural sound is recorded onto the normal audio track along the edge of the tape.

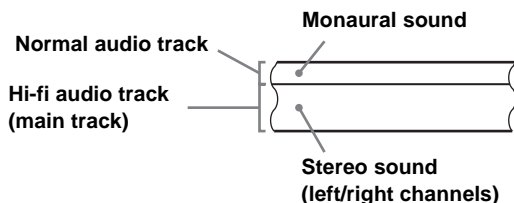

Notes

- To play a tape in stereo, you must use the A/V connections.
- When you play a tape recorded in monaural, the sound is heard in monaural regardless of the AUDIO setting.

Searching using various functions **VHS**

The VCR automatically marks the tape with an index signal at the point where each recording begins.

You can easily find a specific point using various search functions.

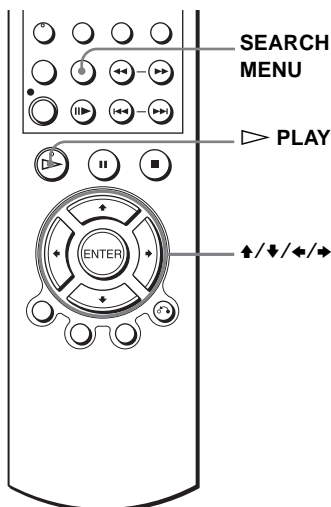

To search using the index function (Scan and Play)

The VCR automatically marks the tape with an index signal at the point where each recording begins. Use these signals as references to find a specific recording.

- 1 Insert an indexed tape into the VCR.
- 2 Press SEARCH MENU.

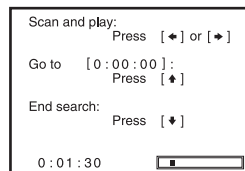

- 3 Press ▶ to scan ahead, or ◀ to scan backwards.
The VCR searches and then plays back for about five seconds.

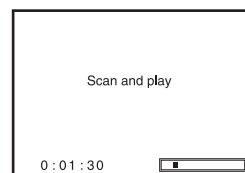

- 4 Press ▷ PLAY to view that program.
If you do not press ▷ PLAY, the VCR automatically searches for the next index mark, or until it reaches the end of the tape.

continued

To search for the counter 0:00:00 point

To mark a point on the tape that you want to find later, reset the tape counter to “0:00:00.”

The VCR automatically fast-forwards or rewinds to the 0:00:00 point on the tape counter.

1 Press SEARCH MENU.

2 Press \blacktriangle .

The VCR starts searching and automatically stops at the 0:00:00 point.

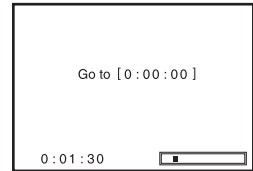

To search for a blank portion of the tape

The VCR automatically searches for the beginning of a blank portion. You can easily find a point you can start recording from.

1 Press SEARCH MENU.

2 Press \blacktriangledown .

The VCR starts searching and automatically stops at the beginning of a blank space. If no blank space is found, the VCR reaches the end.

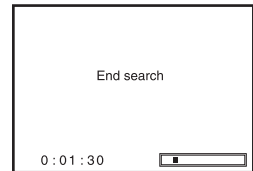

Note

- Once in recording mode, if the VCR is put in pause and then released to start the recording, no index mark will be inserted. An index mark will be inserted if the channel is changed while VCR is put in pause.

Adjusting the picture (tracking) **VHS**

Although the VCR automatically adjusts the tracking when playing a tape, distortion may occur if the recording is in poor condition. In this case, manually adjust the tracking.

Press TRACKING +/- to display the tracking meter. The distortion should disappear as you press one of the two tracking buttons.

To resume automatic tracking adjustment, eject the tape and reinsert it.

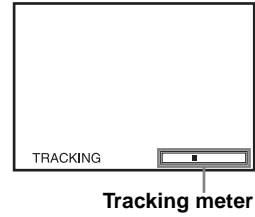



Note

- The auto tracking adjustment cannot be guaranteed to work with tapes recorded in the LP mode on other VCRs.

Changing menu options **VHS**

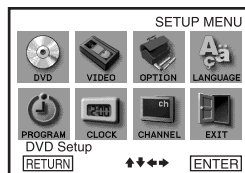
1 Press SET UP when the DVD player is in stop mode.



2 Press $\uparrow/\downarrow/\leftarrow/\rightarrow$ to select  (Video Function Setup), then press ENTER.

The “VIDEO FUNCTION SETUP” menu appears.

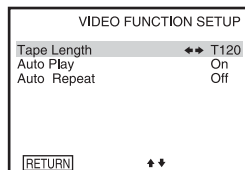

3 Press \uparrow/\downarrow to select the option to change.

4 Press \leftarrow/\rightarrow to change the setting.

5 Press \curvearrowright RETURN repeatedly to exit the menu.

Menu choices

The default settings are indicated in bold print.

Menu option	Set this option to
Tape Length	<ul style="list-style-type: none"> • T-120 when using a T-120 or shorter length tape. • T-160 when using a T-160 length tape. • T-180 when using a T-180 or longer length tape.
Auto Play	<ul style="list-style-type: none"> • On to start playback automatically, when you insert a tape with its safety tab removed. • Off to turn off Auto play. You need to press \triangleright PLAY to start playback, even if you insert a tape with its safety tab removed.
Auto Repeat	<ul style="list-style-type: none"> • On to play back a tape repeatedly. The VCR rewinds a tape to the beginning and restarts playback automatically. • Off to turn off Auto repeat.

Editing with another VCR **VHS**

How to connect to record on this VCR

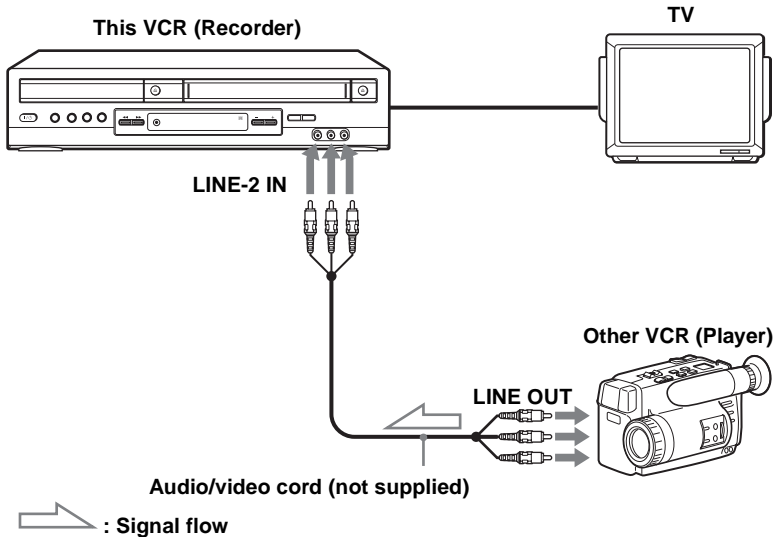

Notes

- Make sure you connect the plugs to jacks of the same color.
- If the other VCR is a monaural type and connected to this VCR's LINE-2 IN jacks, connect the audio plug to the AUDIO L (white) jack. The sound is recorded on both right and left channels. If you connect to the AUDIO R (red) jack, the sound is recorded only on the right channel.
- If you connected this VCR to both the LINE IN and LINE OUT jacks of the other VCR, select the input correctly to prevent a humming noise.
- You can use the LINE IN 1 jacks for editing. If the other VCR is a monaural type the sound is recorded only on the channel whose jack is connected to the audio plug. To record on both right and left channels, connect the audio plugs to the AUDIO L/R jacks using an audio/video cord (not supplied).

continued

Operation (when recording on this VCR)

Before you start editing

- Turn on the VCR and the TV and set it to the video channel.
- Press INPUT SELECT or CH +/- to display “LINE 1” or “LINE 2” in the display window.
- Press SP/EP to select the tape speed, SP or EP.

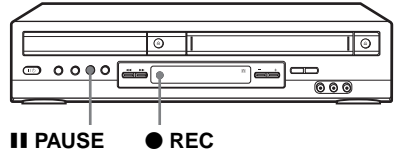

- 1** Insert a source tape with its safety tab removed into the other (playback) VCR. Search for the point to start playback and set it to playback pause.
- 2** Insert a tape into this (recording) VCR. Search for the point to start recording and press **|| PAUSE**.
- 3** Press **● REC** on this VCR to set it to recording pause.
- 4** To start editing, press the **|| PAUSE** buttons on both VCRs at the same time.

To stop editing

Press the **■ STOP** buttons on both VCRs.

Tip

- To cut out unwanted scenes while editing, press **|| PAUSE** on this VCR when an unwanted scene begins. When it ends, press **|| PAUSE** again to resume recording.

General setup information

Changing setup options

1 Press SET UP when the DVD player is in stop mode.

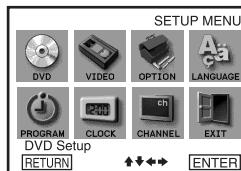

2 Press $\uparrow/\downarrow/\leftarrow/\rightarrow$ to select  (Option setup), then press ENTER.

The “OPTION SETUP” menu appears.

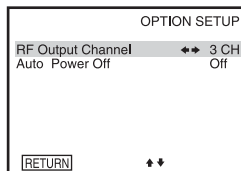

3 Press \uparrow/\downarrow to select the option to change.

4 Press \leftarrow/\rightarrow to change the setting.

5 Press \curvearrowright RETURN repeatedly to exit the menu.

If you have changed the RF Output Channel, a confirmation message appears.

Press ENTER to confirm the changed channel.

Menu choices

Initial settings are indicated in bold print.

Menu option	Set this option to
RF Output Channel	<ul style="list-style-type: none"> • 3CH when using channel 3 to receive the VCR signal. • 4CH when using channel 4 to receive the VCR signal. For details, see page 90.
Auto Power Off	<ul style="list-style-type: none"> • 1Hr to turn off the VCR automatically one hour after the last operation. • 2Hr to turn off the VCR automatically two hours after the last operation. • Off to set no specific time to turn off.

continued

Setting the RF Output channel

When connecting the DVD-VCR to the TV using only the antenna cable, you must set the RF Output channel in the “OPTION SETUP” menu so that the TV can receive the correct signal from the DVD-VCR.

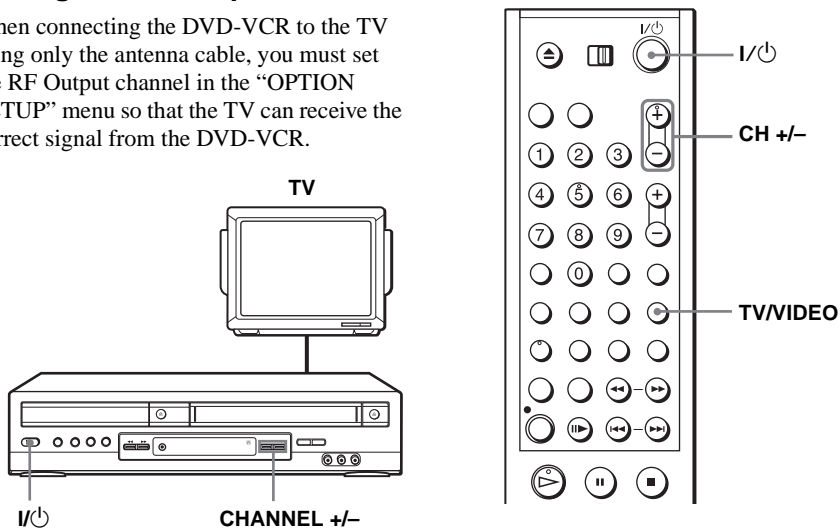

- 1** Set the RF Output channel to “3CH” or “4CH” (see page 89 to set the channel), whichever channel is not used in your area. If both are used, set the switch to either channel.
- 2** Press I/⏻ to turn on the DVD-VCR.
- 3** Press TV/VIDEO to turn on “VCR” in the DVD-VCR’s display window.
- 4** Press CH +/- to display a channel number in the display window. Select an active channel number in your area.
- 5** Turn on your TV and set it to the channel you selected in step 1 (3CH or 4CH). The channel you selected in step 4 appears on the TV screen. If the channels change when you press CH +/-, you have made the correct setting. Whenever you use the DVD-VCR, set the TV to the channel selected in step 1.

Attaching the external antenna connector

When using a 300-ohm twin lead cable for a VHF/UHF antenna, use an antenna connector (not supplied) to connect the antenna to the DVD-VCR.

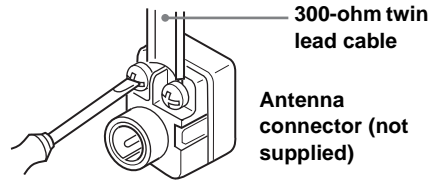

- 1** Loosen the screws on the antenna connector.
- 2** Wind the twin leads around the screws on the antenna connector.
- 3** Retighten the screws.

Attaching a UHF/VHF band mixer

When using both a 75-ohm coaxial cable and a 300-ohm twin lead cable for a VHF/UHF antenna, use a UHF/VHF band separator/mixer (not supplied) to connect the antenna to the DVD-VCR.

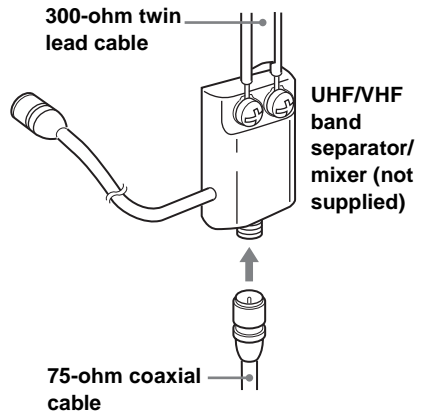

- 1** Loosen the screws on the mixer.
- 2** Wind the twin leads around the screws on the mixer.
- 3** Retighten the screws.
- 4** Connect the 75-ohm coaxial cable to the mixer.

Troubleshooting

If you have any questions or problems not covered below, please consult your nearest Sony dealer. (For customers in USA)

General Troubleshooting

	Symptom	Remedy
Power	The I/⏻ switch does not function.	<ul style="list-style-type: none"> • Connect the AC power cord securely.
	The power is turned on but the DVD-VCR does not operate.	<ul style="list-style-type: none"> • Moisture condensation has occurred. Turn the power off, unplug the AC power cord and leave the DVD-VCR to dry for over three hours.
Clock	The clock has stopped and "--:--" appears in the display window.	<ul style="list-style-type: none"> • The clock stops if the DVD-VCR is disconnected from the wall outlet. Reset the clock (and timer).
Others	The remote commander does not function.	<ul style="list-style-type: none"> • Make sure you are pointing the remote commander at the remote sensor on the DVD-VCR. • Replace all the batteries in the remote commander with new ones if they are weak. • Make sure the <u>TV / DVD-VIDEO</u> switch is set correctly. • Select correctly VIDEO or DVD with the SELECT DVD/VIDEO button.
	The tracking meter does not appear on the screen.	<ul style="list-style-type: none"> • The recording condition of the tape is very poor and tracking cannot be adjusted.
	You cannot control other TVs.	<ul style="list-style-type: none"> • Set your TV's code number. The code number may change when you replace the batteries of the remote commander.

DVD Troubleshooting

	Symptom	Remedy
Picture	There is no picture/picture noise appears.	<ul style="list-style-type: none"> • Re-connect the connecting cord securely. • The connecting cords are damaged. • Check the connection to your TV (page 12) and switch the input selector on your TV so that the signal from the player appears on the TV screen. • The disc is dirty or flawed. • If the picture output from your player goes through your VCR to get to your TV or if you are connected to a combination TV/VIDEO player, the copy-protection signal applied to some DVD programs could affect picture quality. If you still experience problems even when you connect your player directly to your TV, please try connecting your player to your TV's S VIDEO input (page 46). • You have set the player to progressive format (the PROGRESSIVE indicator lights up in blue) even though your TV cannot accept the progressive signal. In this case, press the PROGRESSIVE button on the front panel until the PROGRESSIVE indicator turns off (page 53). • Even if your TV is compatible with progressive format (480p) signals, the image may be affected when you set the player to progressive format. In this case, press the PROGRESSIVE button so that the PROGRESSIVE indicator turns off and the player is set to normal (interlace) format (page 53). • COMPONENT VIDEO OUT jack is not used or "Video Out" of the "SCREEN SETUP" menu is not set correctly while the PROGRESSIVE indicator lights up in blue. Check the setting (page 53) and connection (page 46) or press the PROGRESSIVE button so that the PROGRESSIVE indicator turns off.
	Even though you set the aspect ratio in "TV Type" of the "SCREEN SETUP" menu the picture does not fill the screen.	<ul style="list-style-type: none"> • The aspect ratio of the disc is fixed on your DVD.
	There is no picture from your VCR connected to the LINE IN jacks.	<ul style="list-style-type: none"> • The DVD player must be in standby mode to view pictures from your VCR.
Sound	There is no sound.	<ul style="list-style-type: none"> • Re-connect the connecting cord securely. • The connecting cord is damaged. • The player is connected to the wrong input jack on the amplifier (receiver) (page 13). • The amplifier (receiver) input is not correctly set. • The player is in pause mode or in Slow-motion Play mode. • The player is in fast forward or fast reverse mode. • If the audio signal does not come through the DIGITAL AUDIO OUT (OPTICAL or COAXIAL) jack, check the audio settings (page 48).
	Sound is noisy.	<ul style="list-style-type: none"> • When playing a CD with DTS sound tracks, noise will come from the LINE OUT L/R (AUDIO) jacks (page 30) or DIGITAL OUT (OPTICAL or COAXIAL) jack.
	The sound volume is low.	<ul style="list-style-type: none"> • The sound volume is low on some DVDs. The sound volume may improve if you set "Audio DRC" to "TV Mode" (page 49).

continued

	Symptom	Remedy
Operation	The disc does not play.	<ul style="list-style-type: none"> • The disc is turned over. • Insert the disc with the playback side facing down on the disc tray. • The disc is skewed. • The player cannot play certain discs (page 6). • The region code on the DVD does not match the player. • Moisture has condensed inside the player (page 3). • The player cannot play CD-Rs, CD-RWs, or DVD-Rs that are not finalized (page 7). • Make sure the TV / DVD-VIDEO switch is set correctly. • Select correctly VIDEO or DVD with SELECT DVD/VIDEO button.
	The MP3 audio track cannot be played (page 72).	<ul style="list-style-type: none"> • The DATA CD is not recorded in the MP3 format that conforms to ISO9660 Level 1/Level 2 or Joliet. • The MP3 audio track does not have the extension “.MP3.” • The data is not formatted in MP3 even though it has the extension “.MP3.” • The data is not MPEG1 Audio Layer 3 data. • The player cannot play audio tracks in MP3PRO format.
	The JPEG image file cannot be played.	<ul style="list-style-type: none"> • The DATA CD is not recorded in JPEG format that conforms to ISO9660 Level 1/Level 2 or Joliet. • The JPEG image file does not have the extension “.JPG” or “.JPEG.” • The data is not formatted in JPEG even though it has the extension “.JPG” or “.JPEG.” • Length or width of the image is more than 4720 dots.
	The title of the MP3 audio album/track or JPEG image album/file is not correctly displayed.	<ul style="list-style-type: none"> • The player can only display numbers and alphabet. Other characters are displayed as asterisks.
	The disc does not start playing from the beginning.	<ul style="list-style-type: none"> • Program play, shuffle play, or repeat play, has been selected (pages 63, 65, 66). • Resume play has taken effect (page 29).
	The player starts playing the disc automatically.	<ul style="list-style-type: none"> • The disc features an auto playback function.
	Playback stops automatically.	<ul style="list-style-type: none"> • While playing discs with an auto pause signal, the player stops playback at the auto pause signal.
	You cannot perform some functions such as stop, search, slow-motion play, repeat play, shuffle play, or program play.	<ul style="list-style-type: none"> • Depending on the disc, you may not be able to do some operations. See the operating manual that comes with the disc.
	The language for the sound track cannot be changed.	<ul style="list-style-type: none"> • Try using the DVD’s menu instead of the direct selection button on the remote (page 59). • Multilingual tracks are not recorded on the DVD being played. • The DVD prohibits the changing of the language for the sound track.

	Symptom	Remedy
Operation	The subtitle language cannot be changed or turned off.	<ul style="list-style-type: none"> Try using the DVD's menu instead of the direct selection button on the remote (page 59). Multilingual subtitles are not recorded on the DVD being played. The DVD prohibits the changing of the subtitles.
	The angles cannot be changed.	<ul style="list-style-type: none"> Try using the DVD's menu instead of the direct selection button on the remote (page 59). Multi-angles are not recorded on the DVD being played. The DVD prohibits changing of the angles.
	The player does not operate properly.	<ul style="list-style-type: none"> When static electricity, etc., causes the player to operate abnormally, unplug the player.

VCR Troubleshooting

	Symptom	Remedy
Playback	The playback picture does not appear on the TV screen.	<ul style="list-style-type: none"> Make sure the TV is set to the channel for the VCR. If you are using a monitor, set it to video input.
	The picture is not clear.	<ul style="list-style-type: none"> Adjust the tracking with the TRACKING +/- buttons. The video heads are dirty (see the last page of "Troubleshooting"). Clean the video heads using a Sony video head cleaning cassette. If a Sony cleaning cassette is not available in your area, have the heads cleaned at your nearest Sony dealer (a standard service fee will be charged). Do not use a commercially available liquid type cleaning cassette, as it may damage the video heads. The video heads may have to be replaced. Consult your local Sony dealer for more information.
	The picture rolls vertically during picture search.	<ul style="list-style-type: none"> Adjust the vertical hold control on the TV or monitor.
	The picture has no sound.	<ul style="list-style-type: none"> The tape is defective. If you made A/V connections, check the audio cord connection.
Recording	A TV program does not appear on the TV screen.	<ul style="list-style-type: none"> Make sure the TV is set to the channel for the VCR. If you are using a monitor, set it to video input. Select the correct source with the INPUT SELECT or CH +/- buttons. Select a channel number when recording TV programs; select "L1" or "L2" when recording from other equipment.
	TV reception is poor.	<ul style="list-style-type: none"> Adjust the TV antenna.
	The tape starts playing as soon as it is inserted.	<ul style="list-style-type: none"> The safety tab has been removed. To record on this tape, cover the tab hole.
	The tape is ejected when you press ● REC.	<ul style="list-style-type: none"> Check that the safety tab has not been removed.
	Nothing happens when you press ● REC.	<ul style="list-style-type: none"> Make sure the tape is not at its end.

	Symptom	Remedy
Timer recording	The timer does not operate.	<ul style="list-style-type: none"> • Check that the clock is set. • Make sure a tape has been inserted. • Check that the safety tab has not been removed. • Make sure the tape is not at its end. • Make sure a program has been set for timer recording. • Make sure your timer settings are past the current time. • Check that the cable box is turned on. • The clock stops if the DVD-VCR is disconnected from the wall outlet for more than one minute. Reset the clock and timer. • Turn the power off and unplug the AC power cord.
	A tape cannot be inserted. The VCR mechanism needs to be cleaned.	<ul style="list-style-type: none"> • Check that a tape is not already in the tape compartment. • Clean the cabinet, panel and controls with a dry, soft cloth, or a soft cloth slightly moistened with a mild detergent solution. Do not use any type of solvent, such as alcohol or benzine.
Others	Control by AV mouse is not possible.	<ul style="list-style-type: none"> • The unit is not compatible with satellite TV receiver AV mouse, etc.

Symptoms caused by contaminated video heads

• Normal picture



• Rough picture

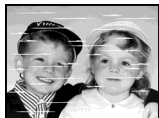

initial
contamination

• Unclear picture



• No picture (or
black & white
screen appears)



terminal



Glossary

Chapter (page 31)

Sections of a picture or a music feature that are smaller than titles. A title is composed of several chapters. Depending on the disc, no chapters may be recorded.

Dolby Digital (page 44 and 49)

Digital audio compression technology developed by Dolby Laboratories. This technology conforms to 5.1-channel surround sound. The rear channel is stereo and there is a discrete subwoofer channel in this format. Dolby Digital provides the same 5.1 discrete channels of high quality digital audio found in Dolby Digital cinema audio systems. Good channel separation is realized because all of the channel data are recorded discretely and little deterioration is realized because all channel data processing is digital.

Dolby Surround (Pro Logic) (page 44)

Audio signal processing technology that Dolby Laboratories developed for surround sound. When the input signal contains a surround component, the Pro Logic process outputs the front, center and rear signals. The rear channel is monaural.

DTS (page 49)

Digital audio compression technology that Digital Theater Systems, Inc. developed. This technology conforms to 5.1-channel surround sound. The rear channel is stereo and there is a discrete subwoofer channel in this format. DTS provides the same 5.1 discrete channels of high quality digital audio.

Good channel separation is realized because all of the channel data is recorded discretely and little deterioration is realized because all channel data processing is digital.

DVD (page 6)

A disc that contains up to 8 hours of moving pictures even though its diameter is the same as a CD.

The data capacity of a single-layer and single-sided DVD is 4.7 GB (Giga Byte), which is 7 times that of a CD. The data capacity of a double-layer and single-sided DVD is 8.5 GB, a single-layer and double-sided DVD is 9.4 GB, and double-layer and double-sided DVD is 17GB.

The picture data uses the MPEG 2 format, one of the worldwide standards of digital compression technology. The picture data is compressed to about 1/40 (average) of its original size. The DVD also uses a variable rate coding technology that changes the data to be allocated according to the status of the picture. Audio information is recorded in a multi-channel format, such as Dolby Digital, allowing you to enjoy a more real audio presence.

Furthermore, various advanced functions such as the multi-angle, multilingual, and Parental Control functions are provided with the DVD.

DVD-RW (page 6)

A DVD-RW is a recordable and rewritable disc that is the same size as a DVD VIDEO. The DVD-RW has two different modes: VR mode and Video mode. DVD-RWs created in Video mode have the same format as a DVD VIDEO, while discs created in VR (Video Recording) mode allow the contents to be programmed or edited.

DVD+RW (page 6)

A DVD+RW (plus RW) is a recordable and rewritable disc. DVD+RWs use a recording format that is comparable to the DVD VIDEO format.

Interlace format (page 53)

Interlace format shows every other line of an image as a single “field” and is the standard method for displaying images on television. The even number field shows the even numbered lines of an image, and the odd numbered field shows the odd numbered lines of an image.

Progressive format (page 47 and 53)

Compared to the Interlace format that alternately shows every other line of an image (field) to create one frame, the Progressive format shows the entire image at once as a single frame. This means that while the Interlace format can show 30 frames/60 fields in one second, the Progressive format can show 60 frames in one second. The overall picture quality increases and still images, text, and horizontal lines appear sharper. This player is compatible with the 480 progressive format.

Title (page 31)

The longest section of a picture or music feature on a DVD, movie, etc., in video software, or the entire album in audio software.

Track (page 31)

Sections of a picture or a music feature on a CD or VIDEO CD (the length of a song).

Specifications

System

- Laser
 - Semiconductor laser
- Format
 - VHS NTSC standard
- Video recording system
 - Rotary head helical scanning FM system
- Video heads
 - Double azimuth four heads
- Video signal
 - NTSC color, EIA standards
- Tape speed
 - SP: 33.35 mm/s (1 $\frac{3}{8}$ inches/s)
 - EP: 11.12 mm/s ($\frac{7}{16}$ inches/s)
 - LP: 16.67 mm/s (1 $\frac{1}{16}$ inches/s), playback only
- Maximum recording/playback time
 - 8 hrs. in EP mode (with T-160 tape)
- Rewind time
 - Approx. 1 min (with T-120 tape)

Tuner section

- Channel coverage
 - VHF 2 to 13
 - UHF 14 to 69
 - CATV A-8 to A-1, A to W, W+1 to W+84
- Antenna
 - 75-ohm antenna terminal for VHF/UHF

Inputs and outputs

- LINE IN 1 and LINE-2 IN
 - VIDEO IN, phono jack (1 each)
 - Input signal: 1 Vp-p, 75 ohms, unbalanced, sync negative
 - AUDIO IN, phono jacks (2 each)
 - Input level: 327 mVrms
 - Input impedance: more than 47 kilohms
- LINE OUT
 - VIDEO OUT, phono jack (1)
 - Output signal: 1 Vp-p, 75 ohms, unbalanced, sync negative
 - AUDIO OUT, phono jacks (2)
 - Standard output: 327 mVrms
 - Load impedance: 47 kilohms
 - Output impedance: less than 10 kilohms
- DIGITAL OUT
 - OPTICAL, Optical output jack
 - 18 dBm (wave length: 660 nm)
 - COAXIAL, phono jack
 - Output signal: 0.5 Vp-p, 75 ohms
- COMPONENT VIDEO OUT (Y, Pb, Pr)
 - Phono jack
 - Y: 1.0 Vp-p/Pb, Pr: 0.7 Vp-p, 75 ohms
- S-VIDEO OUT
 - 4-pin, mini-DIN jack
 - Y: 1.0 Vp-p, unbalanced, sync negative
 - C: 0.286 Vp-p, load impedance 75 ohms

Timer section

- Clock
 - Quartz locked
- Timer indication
 - 12-hour cycle
- Timer setting
 - 8 programs (max.)

General

Power requirements

120 V AC, 60 Hz

Power consumption

28 W

Power back-up

Back-up duration: 0 min

Operating temperature

0°C to 45°C (32°F to 113°F)

Storage temperature

-20°C to 60°C (-4°F to 140°F)

Operating humidity

25% to 80%

Dimensions including projecting parts and controls
(w/h/d)

Approx. 430 × 95 × 295 mm

(Approx. 17 × 3.7 × 12 inches)

Mass

Approx. 4.0 kg (Approx. 8.8 lbs)

Supplied accessories

Remote commander (1)

Size AA (R6) batteries (2)

75-ohm coaxial cable with F-type connectors (1)

Audio/video cord (pinplug ×3 ↔ pinplug ×3) (1)

Design and specifications are subject to change without notice.

Index to parts and controls

Refer to the pages indicated in parentheses () for details.

Front panel

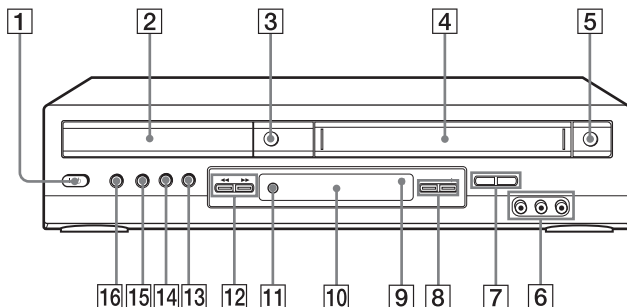

- | | |
|---|---|
| 1 I/⏻ POWER switch (10) (34) | 9 Remote sensor |
| 2 Disc tray (28) | 10 Display window (29) (34) |
| 3 ≡ (open/close) button (28) (29) | 11 ● REC (record) button (37) |
| 4 Tape compartment (36) | 12 ◀◀ (rewind)▶▶ (fast-forward) button (29) (34) |
| 5 ≡ (eject) button (34) | 13 ■ (stop) button (29) (34) |
| 6 LINE-2 IN VIDEO/AUDIO L/R jacks (87) | 14 (pause) button (29) (34) |
| 7 SELECT DVD/VIDEO (9) | 15 ▷ (play) button (29) (34) |
| 8 CHANNEL +/- buttons (36) | 16 PROGRESSIVE button/indicator (47) (53) |

continued

Display window

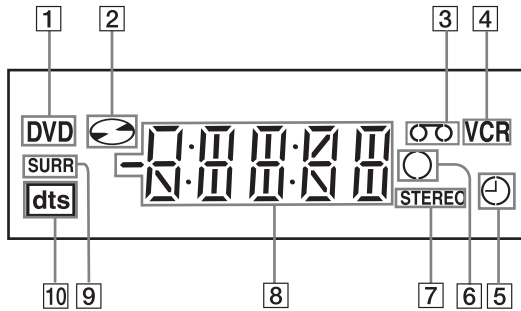

1 DVD indicator (29)

2 Disc indicator (29)

3 Tape indicator (34)

4 VCR indicator (34)

5 Timer indicator (40)

6 Record indicator (37)

7 STEREO indicator (82)

8 Playing time/clock/current status indicator (29)

9 SURR (surround) indicator (70)

10 DTS indicator (49)

Rear panel

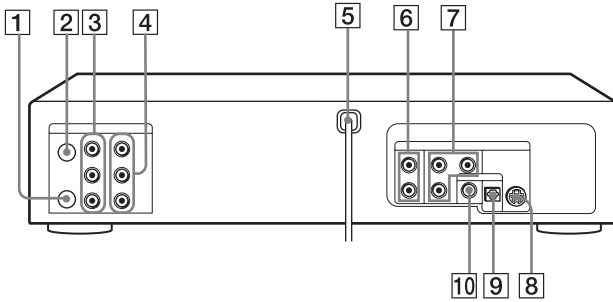

DVD player and VCR

- 1 RF OUT (TO TV) connector (14)
- 2 RF IN (FROM ANT.) connector (14)
- 3 LINE OUT VIDEO/AUDIO L/R jacks (13)
- 4 LINE IN 1 VIDEO/AUDIO L/R jacks (13)
- 5 AC power cord (12) (15) (17)

DVD player only

- 6 LINE OUT AUDIO L/R jacks (46)
- 7 COMPONENT VIDEO OUT Pr/Pb/Y jacks (47)
- 8 S-VIDEO OUT jack (46)
- 9 DIGITAL AUDIO OUT/OPTICAL jack (45)
- 10 DIGITAL AUDIO OUT/COAXIAL jack (45)

Remote commander

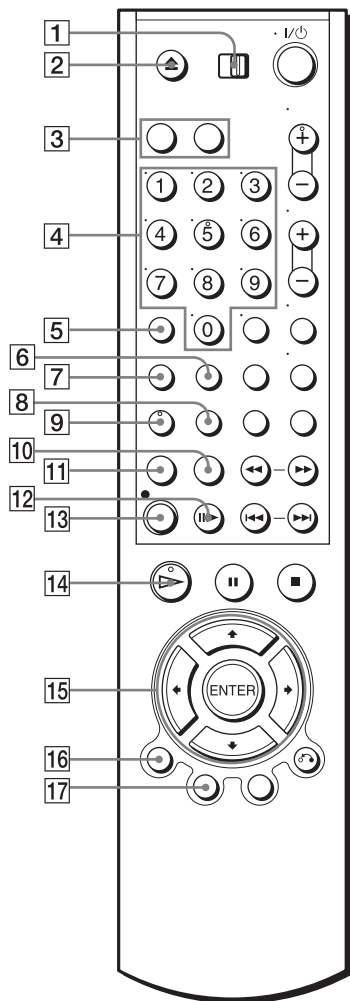

- 1** TV / DVD•VIDEO switch (9)
- 2** ▲ button (28) (29) (34)
[for DVD] (open/close) button
[for VIDEO] (eject) button
- 3** SELECT DVD/VIDEO buttons (9)
- 4** Number buttons* (27)
- 5** CLEAR button (35) (40) (64)
- 6** SURROUND button (70)
- 7** SET UP button (19)
- 8** SUBTITLE/TIMER button (39) (62)
[for DVD] SUBTITLE button
[for VIDEO] TIMER button
- 9** AUDIO button* (69) (82)
- 10** BOOKMARK/SEARCH MENU button
(67) (83)
[for DVD] BOOKMARK button
[for VIDEO] SEARCH MENU button
- 11** REPEAT/REPLAY button (34) (64)
[for DVD] REPEAT button
[for VIDEO] REPLAY button
- 12** ||► SKIP button (29) (35)
- 13** ● REC (record) button (37)
- 14** ▷ PLAY button* (29) (34)
- 15** ▲/▼/◀/▶ button (19)
- 16** DISPLAY button (31) (37)
- 17** TOP MENU button (59)

* Number 5, AUDIO and ▷ PLAY buttons have a tactile dot. Use the tactile dot as a reference when operating the DVD-VCR.

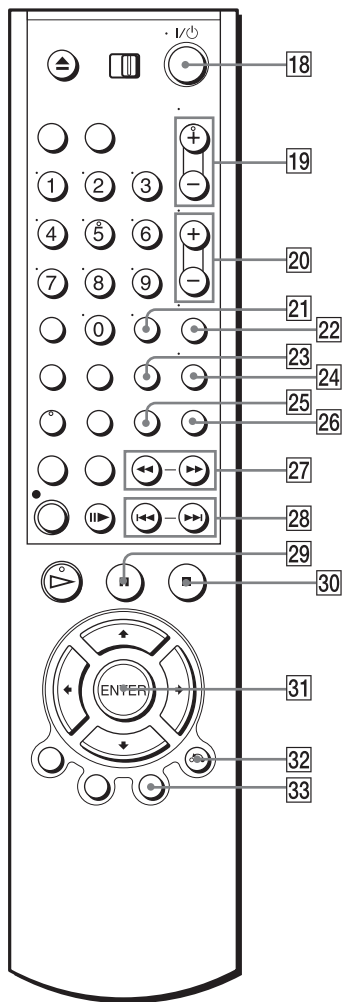

- 18** I/⏻ (power) switch (10) (34)
- 19** CH (channel)/TRACKING +/- buttons*¹ (36) (85)
- 20** VOL (volume) +/- buttons (10)
- 21** ENTER button*² (19)
- 22** MUTING/ZOOM button (10) (60)
[for DVD] ZOOM button
[for VIDEO] No function
[for Sony TV only] MUTING button
- 23** SP (Standard Play)/EP (Extended Play) button (37)
- 24** TV/VIDEO button (38)
- 25** ANGLE button (61)
- 26** INPUT SELECT button (38)
- 27** ◀◀/▶▶ SCAN/SLOW ▶▶ buttons (29) (34)
[for DVD] ◀◀ SCAN button
▶▶ SCAN button
SLOW ▶▶ button
[for VIDEO] ◀◀ (rewind) button
▶▶ (fast-forward) button
SLOW ▶▶ button
- 28** ◀◀/▶▶ SHUTTLE PREV/NEXT button (29) (35)
[for DVD] ◀◀ PREV (previous) button
▶▶ NEXT (next) button
[for VIDEO] ◀◀/▶▶ SHUTTLE button
- 29** || PAUSE button (29) (34)
- 30** ■ STOP button (29) (34)
- 31** ENTER button*² (19)
- 32** ↶ RETURN button (19)
- 33** MENU button (59)

*¹ CH/TRACKING + button has a tactile dot. Use the tactile dot as a reference.

*² The ENTER buttons 21 and 31 can be used interchangeably.

DVD Audio/Subtitle Language

Abbreviation	Language
ARA	Arabic
CHI	Chinese
CRO	Croatian
CZK	Czech
DAN	Danish
DEU	German
ENG	English
ESP	Spanish
FIN	Finish
FRA	French
GRE	Greek
HUN	Hungarian
IDN	Indonesian
IND	Hindi
ISL	Islandic
ITA	Italian
IWR	Hebrew
JPN	Japanese
KOR	Korean
MAL	Malay
NLD	Dutch
NOR	Norwegian
POL	Polish
POR	Portuguese
RUS	Russian
SVE	Swedish
THA	Thai
TUR	Turkish
VIE	Vietnamese
ZAF	Afrikaans

Index

Numerics

16:9 52
4:3 Letter Box 52
4:3 Pan Scan 52

A

Adjusting
 picture 85
 tracking 85
Angle 61
Antenna hookup 14
Audio track 82
Audio/video (A/V) hookup 13
Auto Clock Set 20

B

Bookmark 67

C

Cable hookup 12
Changing menu option 86
Cleaning the video heads 95
Clock setting 20
Commercial Skip 34
Connecting
 Cable TV 18
 external antenna connector
 91
 UHF/VHF band mixer 91
Counter 35

D

DATA CD 6, 72, 76
Disabling channels 26
DOLBY DIGITAL 44, 69
DTS 45, 69
Dubbing. *see* Editing
DVD 6

E

Editing 87
EP mode 37

H

Handling discs 7
Hi-fi audio track 82

J

JPEG 6, 76

L

Language selecting 19
LP mode 38

M

Monaural 82
Monitoring audio during
 playback 82
MP3 6, 72

N

Normal audio track 82

P

Parental Control 56
PBC (Playback control) 79
Picture adjustment 85
Playback 28
 at various speeds 29, 34
 frame by frame 29, 35
 MP3 audio track 72
 program play 63
 repeat play 66
 selecting the sound 82
 shuffle play 65
 skip 34
 slow motion 30, 35
 VIDEO CDs 79
Presetting channels 24
Program play 63
Progressive 47, 98

R

Recording
 bilingual programs 82
 SAP broadcasts 82
 saving 38
 stereo broadcasts 82
 while watching another
 program 38, 41
Repeat play 66
RF channel 90

S

Safety tab 38
SAP (Second Audio Program)
82
Searching
 at various speeds 29, 34
 for a blank portion 84
 for the counter 0 point 84
 Scan and Play 83
Shuffle play 65
SP mode 37
STEREO 69
Stereo 82
Subtitle 62

T

Timer setting
 daily/weekly recording 41
Tracking adjustment. *see*
Adjusting

U

Usable discs 6

V

VIDEO CD 6

Z

Zoom 60

